

EUROFAST[®]

“Fixed quality”

BEVESTIGINGSSYSTEMEN VOOR PLAT DAK



Het Sales Team

OPENINGSTIJDEN

07.30 - 17.30 uur maandag t/m vrijdag

BESTELLEN

E-mail sales@eurofastgroup.com

Telefoon +31 493 31 58 85

Webshop www.eurofastgroup.com

LEVERINGEN

Indien mogelijk zullen orders met levering binnen Nederland de volgende werkdag loopdag uitgeleverd worden, mits deze voor 15.00 uur bij het Sales Team binnen zijn gekomen en voorradig zijn. Voor orders met een levering buiten Nederland, of indien er producten niet voorradig zijn, zal het Sales Team je op de hoogte stellen van de leverdatum. Indien gewenst is levering op een specifiek tijdstip mogelijk in overleg met het Sales Team.

Disclaimer

Afbeeldingen in deze catalogus kunnen afwijken van het werkelijke product. Teksten zijn onder voorbehoud van drukfouten en/of wijziging. Eurofast behoudt zich het recht voor deze gegevens te allen tijde te wijzigen.

Index

01	Introductie	Pag. 4
02	Dakbevestigings voor stalen ondergrond	Pag. 14
03	Dakbevestigings voor houten ondergrond	Pag. 66
04	Dakbevestigings voor gasbetonnen ondergrond	Pag. 88
05	Dakbevestigings voor betonnen ondergrond	Pag. 104
06	Dakbevestigings voor houtwolcementen ondergrond	Pag. 138
07	Tules en drukverdeelplaten	Pag. 142
08	Universele toepassingen	Pag. 166
09	Gereedschap & toebehoren	Pag. 172
10	Ergonomische verwerkingsmachines	Pag. 178

Wij verhogen het gemak: Een kleur gecodeerde deksel per ondergrond.



Staal



Hout



Gasbeton



Beton

EUROFAST®

Introductie



Introductie

Wij zijn jouw partner in mechanische bevestigingsoplossingen voor de gebouwschil.

Eurofast is fabrikant van het toonaangevende merk Eurofast® en een full-service technisch adviesbureau voor het mechanisch bevestigen van de gebouwschil.

Bij Eurofast streven we ernaar onze klanten zoveel mogelijk te ontzorgen in hun zoektocht naar de meest geschikte mechanische bevestigingsoplossing, voor hun specifieke situatie. Zodat elke gebouwschil kwalitatief hoogwaardig bevestigd kan worden.

Wij bieden een breed assortiment bevestigingsmiddelen aan voor het mechanisch bevestigen van Plat dak- en Dak & Wand constructies, voor zowel industriële en commerciële gebouwen. Aangevuld met een full-service pakket bestaande uit onder andere verschillende berekeningen, om jou bij elke stap van het bevestigingsproces te ondersteunen.

Introductie

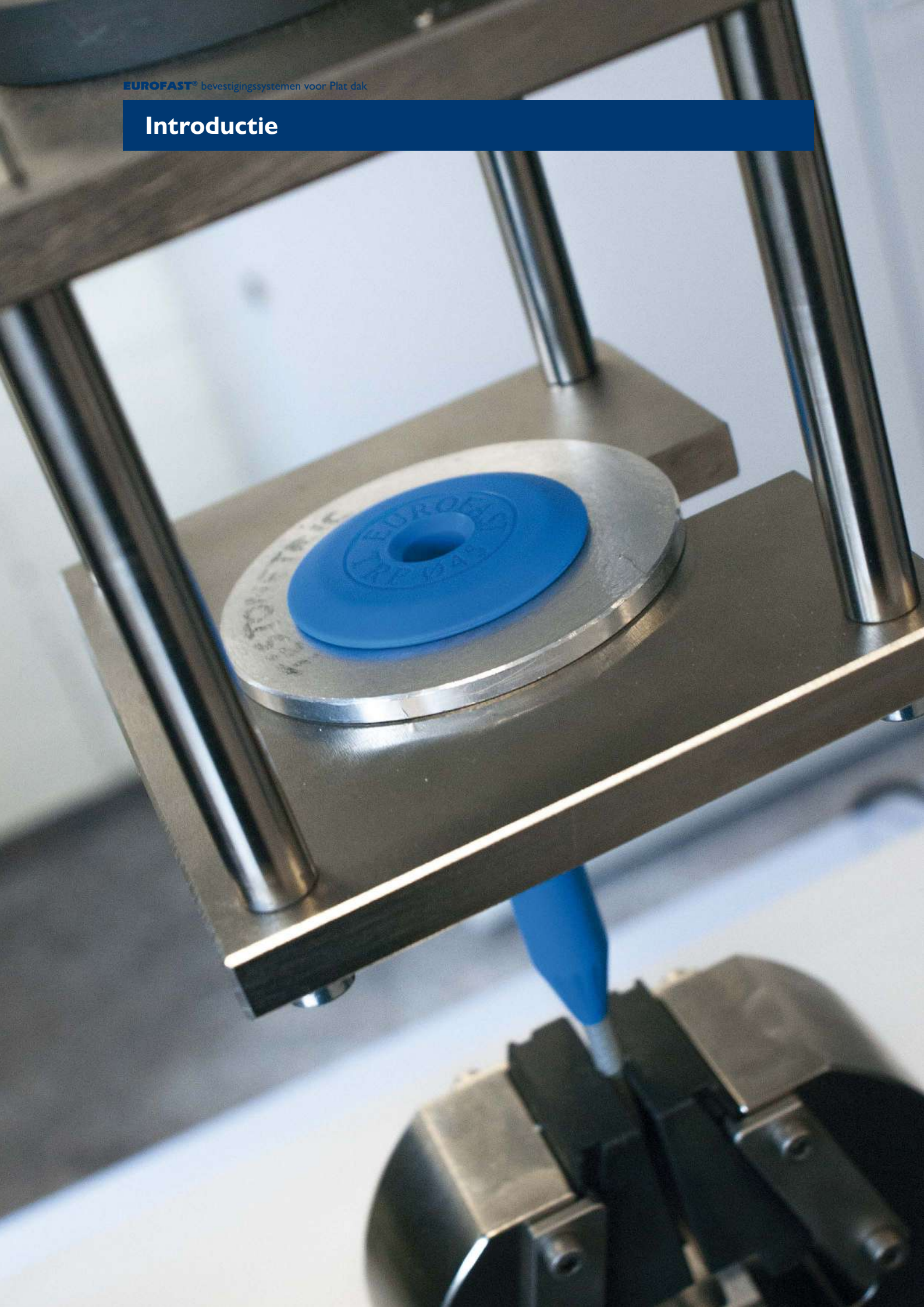

Introductie

Eurofast

is in Nederland opgericht in 1977. Verder hebben we Business Units en divisies in Hongarije, Polen, België, het Verenigd Koninkrijk en Denemarken. Hierdoor kunnen we samen ruim 25 Europese landen bedienen.

Elk bevestigingsproject is uniek en komt met een verschillende behoeften op het gebied van benodigde producten en diensten. Bij Eurofast zijn we ons hier zeer van bewust en helpen wij je graag met advies op maat voor jouw specifieke situatie. Hierbij houden we rekening met de individuele benadering van een land ten aanzien van bevestigen en jouw eigen voorkeuren. Wij helpen je bij het vinden van de beste oplossing voor jouw project.

Met gepaste trots presenteren wij onze vernieuwde product catalogus.

Mocht je vragen hebben dan staat ons team voor jou klaar.

Kjell Verdonshot
Chief Executive Officer C.E.O.



Introductie



Quality Centre

Alle bevestigingsoplossingen van Eurofast voldoen aan de hoogste internationale eisen en normen. Om deze standaarden te garanderen en ervoor te zorgen dat onze klanten altijd producten van hoge kwaliteit ontvangen, voeren we non-stop kwaliteitscontrole uit op onze geproduceerde producten in ons Quality Centre.

BIM

Eurofast is BIM-ready. Wij bieden de mogelijkheid om BIM-data én BIM-content van Eurofast® bevestigers te gebruiken. Eurofast levert je alle essentiële informatie van onze bevestigers aan, die nodig is om van een dakopbouw of gevelconstructie een compleet BIM-model te creëren. Wij adviseren je graag welke bevestiger het meest geschikt is voor jouw toepassing. Daarna ontvang je van ons een BIM-model van de bevestiger op maat. Voor vragen over BIM kun je contact opnemen via bim@eurofastgroup.com

Introductie

Certificeringen

Eurofast beschikt over de volgende certificeringen:

EOTA CE

ETA-06/007

FM Approval

Approval Identification 3049679 + 452785

SINTEF

Certification 2607

ÉMI Non-profit Llc.

A-42/2018

Voor de actuele certificaten kunt u terecht op onze website.



Approval Identification: 3049679 + 452785

FM Approval

Diverse producten uit het Eurofast programma hebben een **FM Approval** behaald.

Dit toonaangevende Amerikaanse keurmerk wordt door veel internationale bedrijven wereldwijd erkend als een vereiste indicatie voor kwaliteit en veiligheid.

De volgende producten zijn in de certificering opgenomen:

Schroeven

- EDS-S 4.8
- EDS-B 4.8
- EFHD 6.3
- EDS-BZT
- EDS-BGT

Schroef/tule combinaties

- TRPS-45
- TRPB-45
- TRPSG-45
- TRPBG-45
- TLKEFHD-45
- TLKEFHD-75

Drukverdeelplaten

- DVP-EFB-51NS
- DVPEFZK8240D

Voor vragen over FM projecten kunt u terecht bij uw contactpersoon, onze Internal Sales

+31 493 31 58 85 of via sales@eurofastgroup.com

Introductie

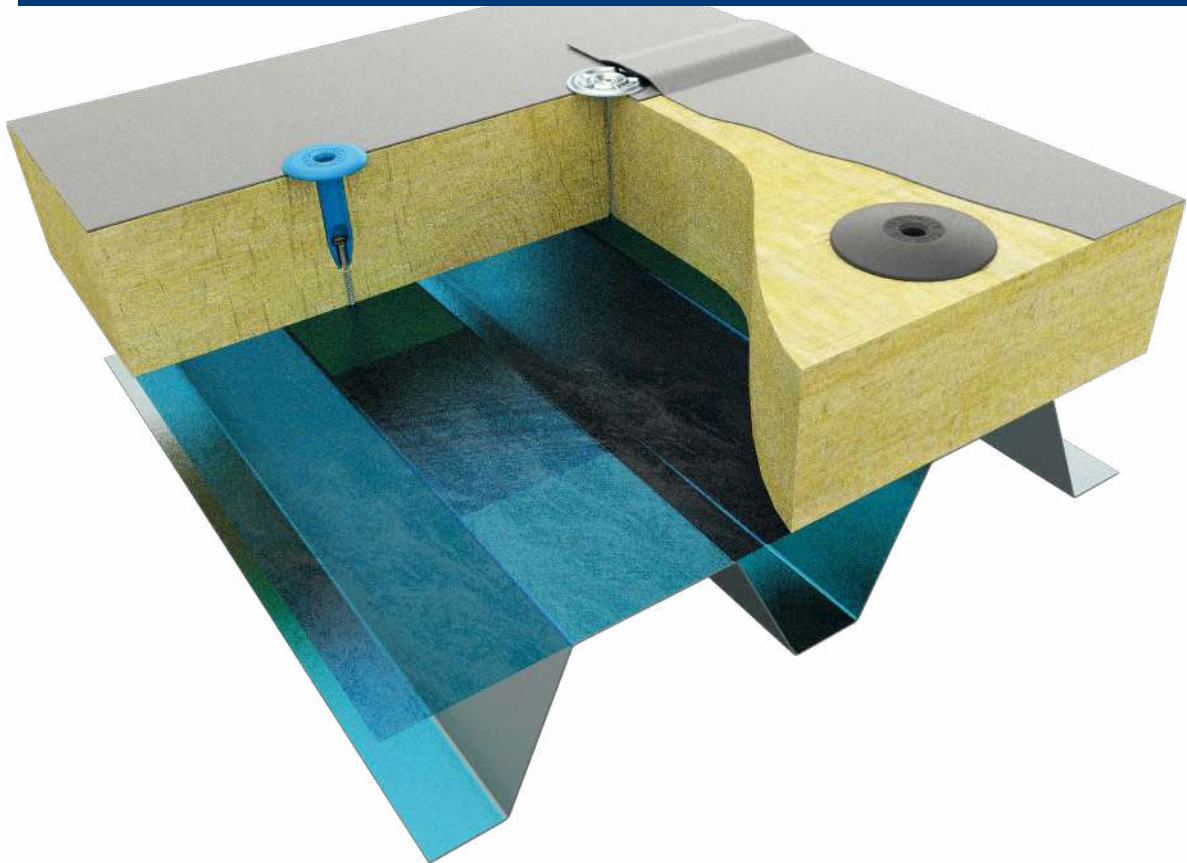

Productontwikkeling

Bij Eurofast zijn we constant op zoek naar manieren om onze producten te verbeteren, huidige producten aan te passen aan veranderende behoeften of volledig nieuwe producten te creëren. Allemaal met als doel om onze klanten toegevoegde waarde te bieden, zowel qua toepassing als kwaliteit.

Deze ontwikkelingen gaan verder dan alleen onze bevestigingssystemen. We ontwikkelen ook gereedschappen en machines om je te helpen bij de juiste verwerking van onze bevestigingsmiddelen.

Technical Department

Onze Technische afdeling staat tot je dienst voor reparatie en onderhoud van alle machines die bij Eurofast zijn aangekocht. Ook geven zij jou advies over het huren van onze machines.

Mini wind uplift tester

Eurofast heeft de middelen om in eigen huis een mini wind uplift test uit te voeren. Deze mini wind uplift tester maakt het mogelijk om samen met klanten en dakbaan producenten te testen of een specifieke combinatie van producten een gewenst resultaat geeft.

Introductie



Technische Ondersteuning & Diensten

Als full-service technisch adviesbureau bieden wij een totaal servicepakket aan, om je te ondersteunen bij elke stap van het bevestigingsproces. Zowel nieuwbouw als renovatie. Op aanvraag verzorgen wij windlast- en afschotberekeningen. Wij doen uittrekproeven op locatie en geven advies op maat voor het correct bevestigen van jouw projecten.

Berekeningen en overige Ondersteuning & Diensten kan je aanvragen via onze website www.eurofastgroup.com. Je ontvangt dan zo snel mogelijk een passend advies.

Koudebrug

Nu en in de toekomst zullen de isolatiepakketten dikker worden vanwege strengere voorschriften. Het zgn. koudebrug effect speelt hierin een steeds belangrijkere rol. Om verlies aan de koudebrug te compenseren is een dikker isolatiepakket noodzakelijk. Een alternatief is de toepassing van kunststof tules met metalen schroeven. Eurofast heeft hiervoor haar tule systeem ontwikkeld, wat bestaat uit hoogwaardige polyamide (PA6) of standaard polypropyleen (PP). Deze kunststof producten onderbreken de koudebrug en weerstaan temperatuurschommelingen en mechanische belasting op diverse applicaties.

Karakteristieke waarden

Drukverdeelplaten	Staal 0,7 - 0,88 mm		Staal 0,7 - 2x 1,25 mm				Staal 3,0 mm	Staal ≥ 0.63 - 2x 1,25 mm	
	EDS-S-48	EFHD-63	EDS-BZT-48 EDS-BGT-48	EDS-BZTR-48 EDS-BGTR-48	EDS SRB-48	EDS-B-48	EDS-B-55	EDS-BZTHD-48 EDS-BGTHD-48	DFHD-67
DVP-EF/DF-8240D/R	1370	1320	1230	1090	1030	1390	1390	1680	
DVP-EFB/DFB-8240D/H	1280	1280	1280	1090	1030	1280	1280	1280	
DVPEFZK8240D			1340	1090				4150	
DVP-EF-5010N/D	1370	1320	1320	1090	1030	1390	1390	1940	1860
DVP-EF-5010DFR	1370								
DVP-EF-4010N/N3									
DVP-K-4040H	1490								
DVP-EF-7007N/D/H	1490	1320	1340	1090	1030	1390	1390	3910	
DVP-EF-7010 N/D	1490	1320	1340	1090	1030	1390	1390	3910	1860
DVP-EF-7010DFR	1490								
DVP-EF/DF-7070 D			1340	1090				3910	
DVP-EF-8040D/N	1490	1320	1320	1090	1030	1310	1310	3510	
DVP-EF-8240XH	1490		1320	1090	1030	1310	1310	3510	
DVP-EF-7005D/N	1290				1030	1290	1290		
DVP-DF-8240H/XH	1490	1320	1320	1090	1030	1310	1310	3510	
DVP-EFB-51NS	1490	1320			1030	1390	1390		1860
DVP-EF-51N	1490	1320			1030	1390	1390		1860
EDF-BAR-F/FB	1110	1110	1110	1110	1030	1110	1110	1110	
KMT/DVPKMT-8240	1490	1320			1490	1490	1490		

Tules

TWP-8040xxx	1160				1030	1160	1160		
TLK-45xxx	1260	1260			1030	1260	1260		
TLK-75xxx	1260	1260			1030	1260	1260		
TRP-45xxx	1260				1030	1260	1260		
BTRP-45xxx	1260				1030	1260	1260		
BIO-45xxx	1260				1030	1260	1260		

Tule/nagel combinaties

ISPC-50xxx									
ISPC-70N									
ISPC-A2									

Karakteristieke waarden

	Gasbeton			Beton					Hout				
Drukverdeelplaten	Schroeven												
	GBSA2-60	GBS-60	GBS-80	ISPC	EFHD-63	DFCF-67	EFR-63	EAS-63	EDS-B-48	EDS-BZT-48 EDS-BGT-48	EDS-B-55	EDS-H-50	EFHD-63
DVP-EF/DF-8240D/R	1680	1440			1680	1680	1680						1680
DVP-EFB/DFB-8240D/H					1280	1280	1280		1280	1280	1280	1280	1280
DVPEFZK8240D									1330	1330	1530	1330	
DVP-EF-5010N/D	1940	1440			1490	1940	1720		1330	1330	1330	1340	1500
DVP-EF-5010DFR	1940	1440							1330	1330	1330	1330	
DVP-EF-4010N/N3	1200	1200										1200	
DVP-K-4040H													
DVP-EF-7007N/D/H	1940	1440			3510	3910	1720		1330	1330	1330	1330	1950
DVP-EF-7010 N/D	1940	1440			3510	3910	1720		1330	1330	1330	1330	1950
DVP-EF-7010DFR	1940	1440							1330	1330	1330	1330	
DVP-EF/DF-7070 D	1940	1440			3510	3910	1720		1330	1330	1350	1340	
DVP-EF-8040D/N													
DVP-EF-8240XH									1330	1330	1330	1330	
DVP-EF-7005D/N									1290	1290	1290	1290	
DVP-DF-8240H/XH	1940	1940			3510	3910	1720		1330	1330	1330	1330	1950
DVP-EFB-51NS	1860	1440			1860	1860	1720		1330		1330	1330	1860
DVP-EF-51N	1860	1440			1860		1720		1330		1330	1330	1860
EDF-BAR-F/FB	1110	1110	1110		1110		1110		1110	1110	1110	1110	1110
KMT/DVPKMT-8240	1490	1440			1490		1490		1330		1490	1340	1490

Tules

TWP-8040xxx									1160		1160	1160	1160
TLK-45xxx	1720	1390	1390		1510		1260	1540	1330		1330	1150	1720
TLK-75xxx	1150	1150	1150		1510		1260	1540	1150		1150	1150	1150
TRP-45xxx					2990		1260	3000	1260		1260	1260	
BTRP-45xxx					2990		1260	3000	1260		1260	1260	
BIO-45xxx	1510	1440					1260	1260				1260	

Tule/nagel combinaties

ISPC-50xxx				1650									
ISPC-70N				1750									
ISPC-A2				1720									

Dakbevestigers voor stalen ondergrond

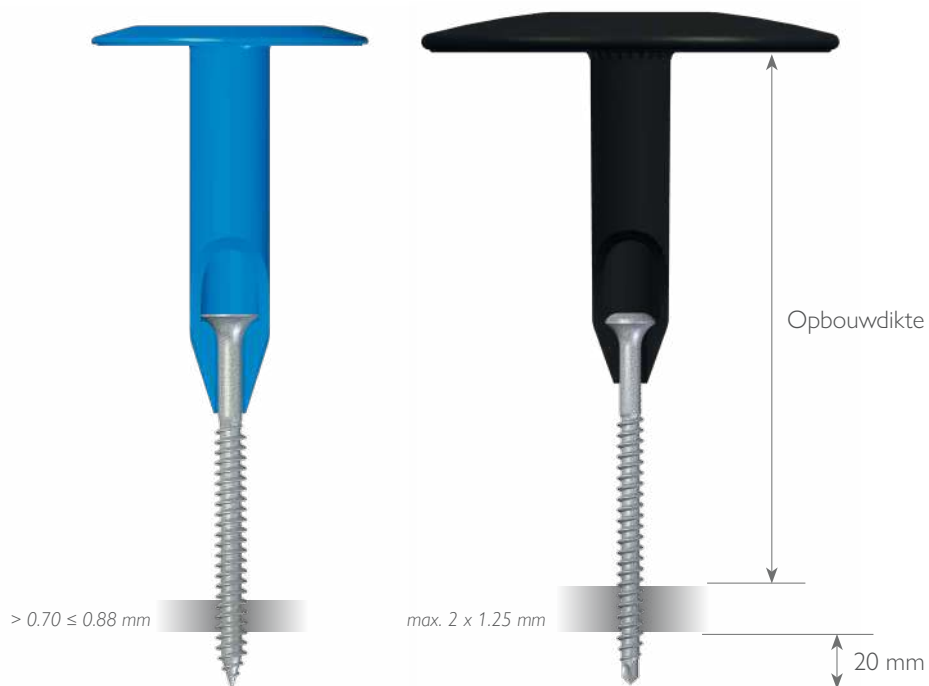
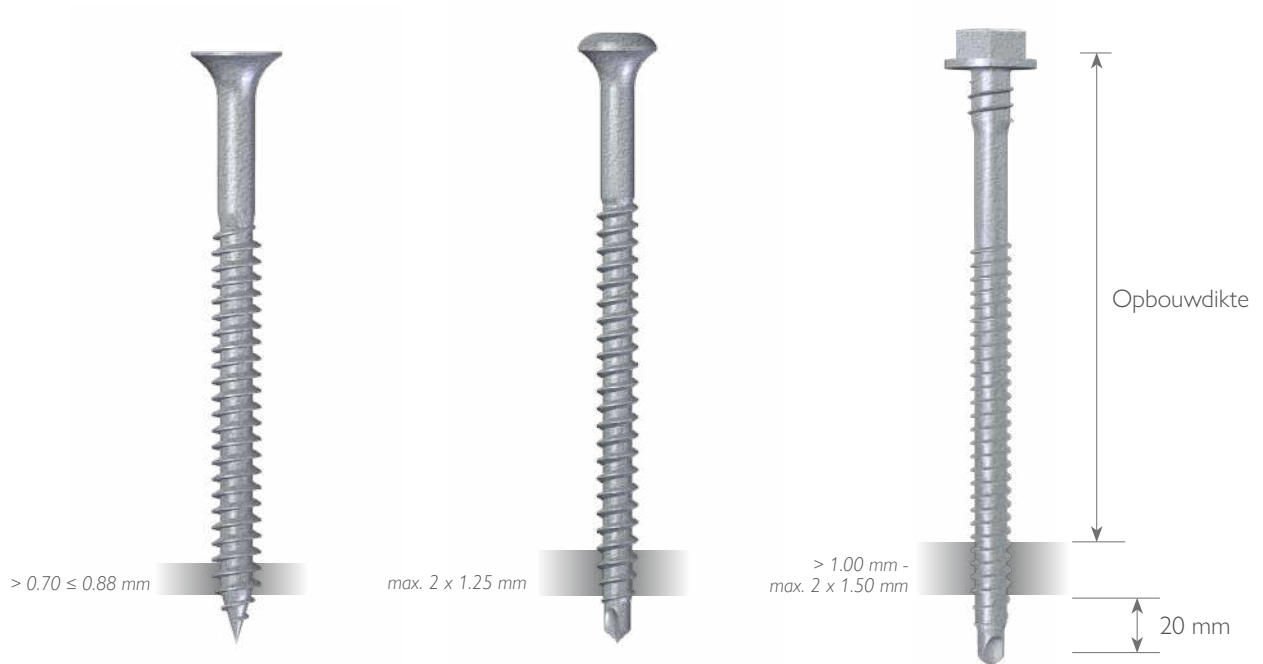

Dakbevestigers voor stalen ondergrond

15-cycli Kesternich

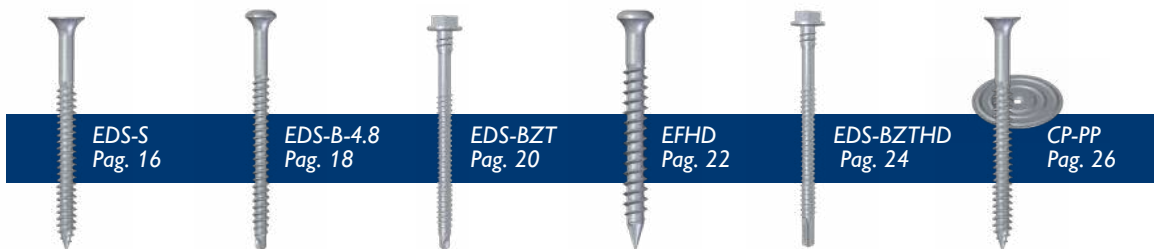

30-cycli Kesternich

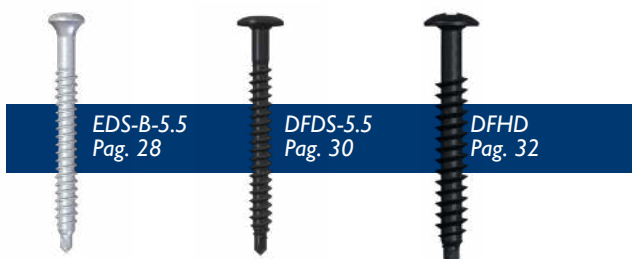

Bi-metaal



15-cycli Kesternich - Tule combinatie

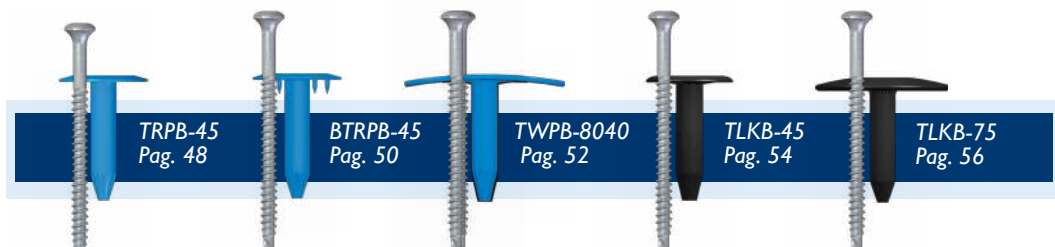
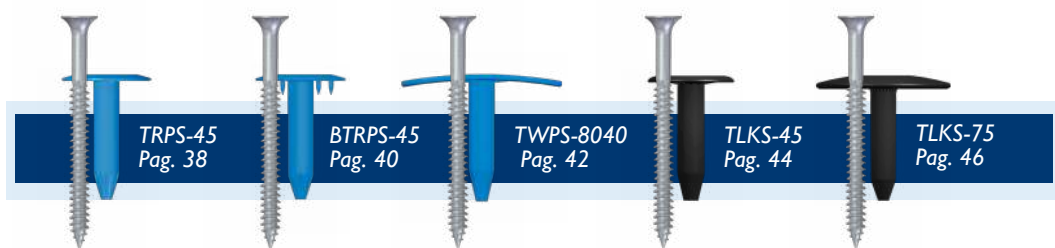

Bi-metaal - Tule combinatie

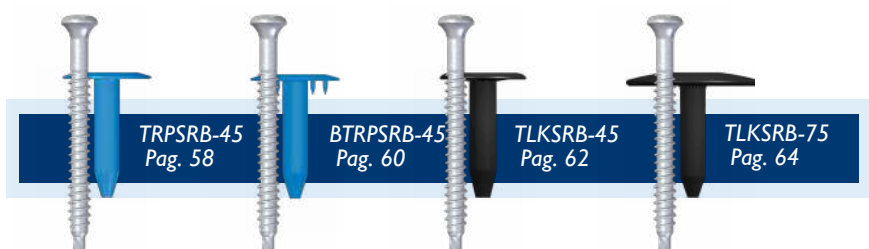

Stalen ondergrond > 0.70 ≤ 0.88 mm

EUROFAST® EDS-S

15-CYCLI KESTERNICH

PH2 bitopname
Incl. EF-kopmarkering

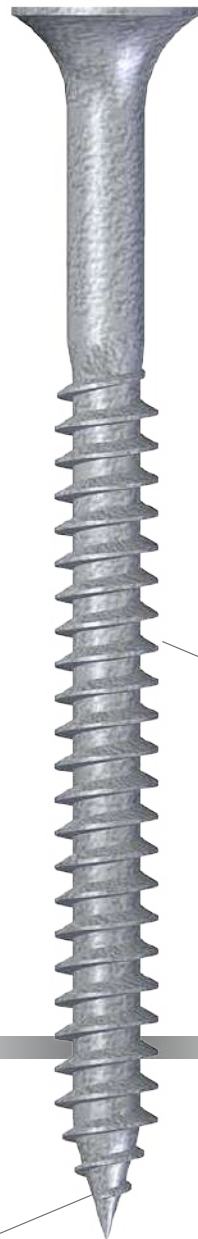

Materiaal
Staal verzinkt met
Magni-Silver coating

Staaldikte
> 0.70 ≤ 0.88 mm



Aanbevolen doorsteek lengte
20 mm door de stalen dakplaat

Punt
Geharde S-punt

Stalen ondergrond > 0.70 ≤ 0.88 mm

Product key	Afmetingen			☒
	Ø	Schroef	Draad	
EDS-S-48025	4.8	25	20	1000
EDS-S-48030	4.8	30	25	1000
EDS-S-48040	4.8	40	35	1000
EDS-S-48050	4.8	50	45	1000
EDS-S-48060	4.8	60	55	500
EDS-S-48070	4.8	70	60	500
EDS-S-48080	4.8	80	70	500
EDS-S-48090	4.8	90	80	500
EDS-S-48100	4.8	100	80	500
EDS-S-48110	4.8	110	80	500
EDS-S-48120	4.8	120	80	500
EDS-S-48130	4.8	130	80	500
EDS-S-48140	4.8	140	80	500
EDS-S-48150	4.8	150	80	500
EDS-S-48160	4.8	160	80	500
EDS-S-48170	4.8	170	80	500
EDS-S-48180	4.8	180	80	500
EDS-S-48200	4.8	200	80	500
EDS-S-48220	4.8	220	80	500
EDS-S-48240	4.8	240	80	500
EDS-S-48260	4.8	260	80	500
EDS-S-48280	4.8	280	80	500
EDS-S-48300	4.8	300	80	500

Stalen ondergrond ≤ max 2 x 1.25 mm

EUROFAST® EDS-B-4.8

15-CYCLI KESTERNICH



Torx 25 bitopname
Incl. EF-kopmarkering

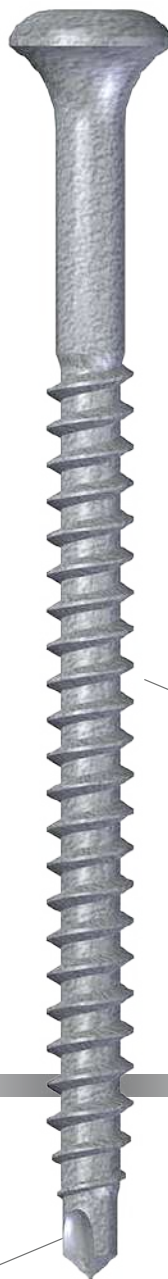

Materiaal

Staal verzinkt met
Magni-Silver coating

Staaldikte
≤ max 2 x 1.25 mm

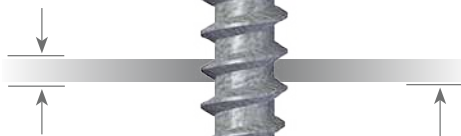

Aanbevolen doorsteek lengte
20 mm door de stalen dakplaat

Punt
Gereduceerde boorpunt

Stalen ondergrond ≤ max 2 x 1.25 mm

Product key	Afmetingen			☒
	Ø	Schroef	Draad	
EDS-B-48035	4.8	35	30	1000
EDS-B-48050	4.8	50	45	1000
EDS-B-48060	4.8	60	50	1000
EDS-B-48070	4.8	70	50	1000
EDS-B-48080	4.8	80	50	1000
EDS-B-48090	4.8	90	50	1000
EDS-B-48100	4.8	100	80	500
EDS-B-48110	4.8	110	80	500
EDS-B-48120	4.8	120	80	500
EDS-B-48130	4.8	130	100	500
EDS-B-48140	4.8	140	100	500
EDS-B-48150	4.8	150	100	500
EDS-B-48180	4.8	180	120	500
EDS-B-48210	4.8	210	120	500
EDS-B-48240	4.8	240	120	500
EDS-B-48260	4.8	260	120	500
EDS-B-48280	4.8	280	120	500
EDS-B-48300	4.8	300	120	500

Stalen ondergrond ≤ max 2 x 1.25 mm

EUROFAST® EDS-BZT

15-CYCLI KESTERNICH



Extra optie

Ook verkrijgbaar op band voor machinale verwerking



Stalen ondergrond ≤ max 2 x 1.25 mm

Product key	Afmetingen			
	Ø	Schroef	Draad	☒
EDS-BZT48060	4.8	60	50	500
EDS-BZT48070	4.8	70	50	500
EDS-BZT48080	4.8	80	50	500
EDS-BZT48090	4.8	90	50	500
EDS-BZT48100	4.8	100	50	500
EDS-BZT48120	4.8	120	75	500
EDS-BZT48140	4.8	140	75	500
EDS-BZT48160	4.8	160	105	500
EDS-BZT48180	4.8	180	120	500
EDS-BZT48200	4.8	200	120	500
EDS-BZT48220	4.8	220	120	500
EDS-BZT48240	4.8	240	120	500
EDS-BZT48260	4.8	260	120	500
EDS-BZT48280	4.8	280	120	500
EDS-BZT48300	4.8	300	120	500

Machinale verwerking

Eurofast® DEK-FIX



Machinale verwerking

EDS-BGT48060	4.8	60	50	1200
EDS-BGT48070	4.8	70	50	1200
EDS-BGT48080	4.8	80	50	1200
EDS-BGT48090	4.8	90	50	1200
EDS-BGT48100	4.8	100	50	1050
EDS-BGT48120	4.8	120	75	1050
EDS-BGT48140	4.8	140	75	750
EDS-BGT48160	4.8	160	105	750
EDS-BGT48180	4.8	180	120	750
EDS-BGT48200	4.8	200	120	750
EDS-BGT48220	4.8	220	120	750
EDS-BGT48240	4.8	240	120	750

Stalen ondergrond ≤ max 2 x 1.25 mm

EUROFAST® EFHD

15-CYCLI KESTERNICH



Torx 25 bitopname
Incl. EF-kopmarkering

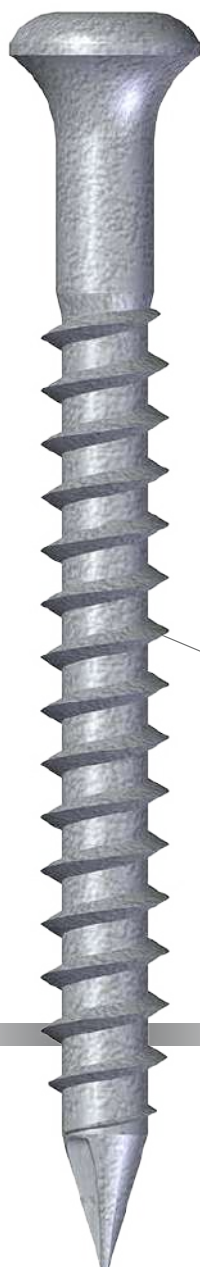

Materiaal

Staal verzinkt met
Magni-Silver coating

Staaldikte
≤ max 2 x 1.25 mm

Aanbevolen doorsteek lengte
20 mm door de stalen dakplaat

Punt
Ricoh punt

Stalen ondergrond ≤ max 2 x 1.25 mm

Product key	Afmetingen			
	Ø	Schroef	Draad	☒
EFHD-63030	6.3	30	25	1000
EFHD-63045	6.3	45	40	1000
EFHD-63060	6.3	60	55	500
EFHD-63070	6.3	70	60	500
EFHD-63080	6.3	80	60	500
EFHD-63100	6.3	100	70	500
EFHD-63130	6.3	130	70	500
EFHD-63160	6.3	160	70	500
EFHD-63180	6.3	180	70	500
EFHD-63200	6.3	200	70	500
EFHD-63230	6.3	230	70	500
EFHD-63250	6.3	250	70	500
EFHD-63275	6.3	275	70	500
EFHD-63300	6.3	300	70	500
EFHD-63330	6.3	330	70	500
EFHD-63350	6.3	350	70	500
EFHD-63400	6.3	400	70	250

Stalen ondergrond > 1.00 - max 2 x 1.50 mm

EUROFAST® EDS-BZTHD

15-CYCLI KESTERNICH



Extra optie

Ook verkrijgbaar op band voor machinale verwerking



HWH 8 mm kop
Incl. EF-kopmarkering



Stapzeker

Materiaal

Staal verzinkt met
Magni-Silver coating

Staaldikte

> 1.00 mm -
max 2 x 1.50 mm



Aanbevolen doorsteek lengte

20 mm door de stalen dakplaat

Punt

Gereduceerde boorpunt

Stalen ondergrond > 1.00 - max 2 x 1.50 mm

Product key	Afmetingen			
	Ø	Schroef	Draad	☒
EDS-BZTHD48140	4.8	140	105	500
EDS-BZTHD48180	4.8	180	120	500
EDS-BZTHD48220	4.8	220	120	500
EDS-BZTHD48260	4.8	260	120	500
EDS-BZTHD48300	4.8	300	120	500

Machinale verwerking

Eurofast® DEK-FIX



Machinale verwerking

EDS-BGTHD48140	4.8	140	105	750
EDS-BGTHD48180	4.8	180	120	750
EDS-BGTHD48220	4.8	220	120	750

Stalen ondergrond > 0.70 ≤ 0.88 mm

EUROFAST® Combi CP-PP

15-CYCLI KESTERNICH

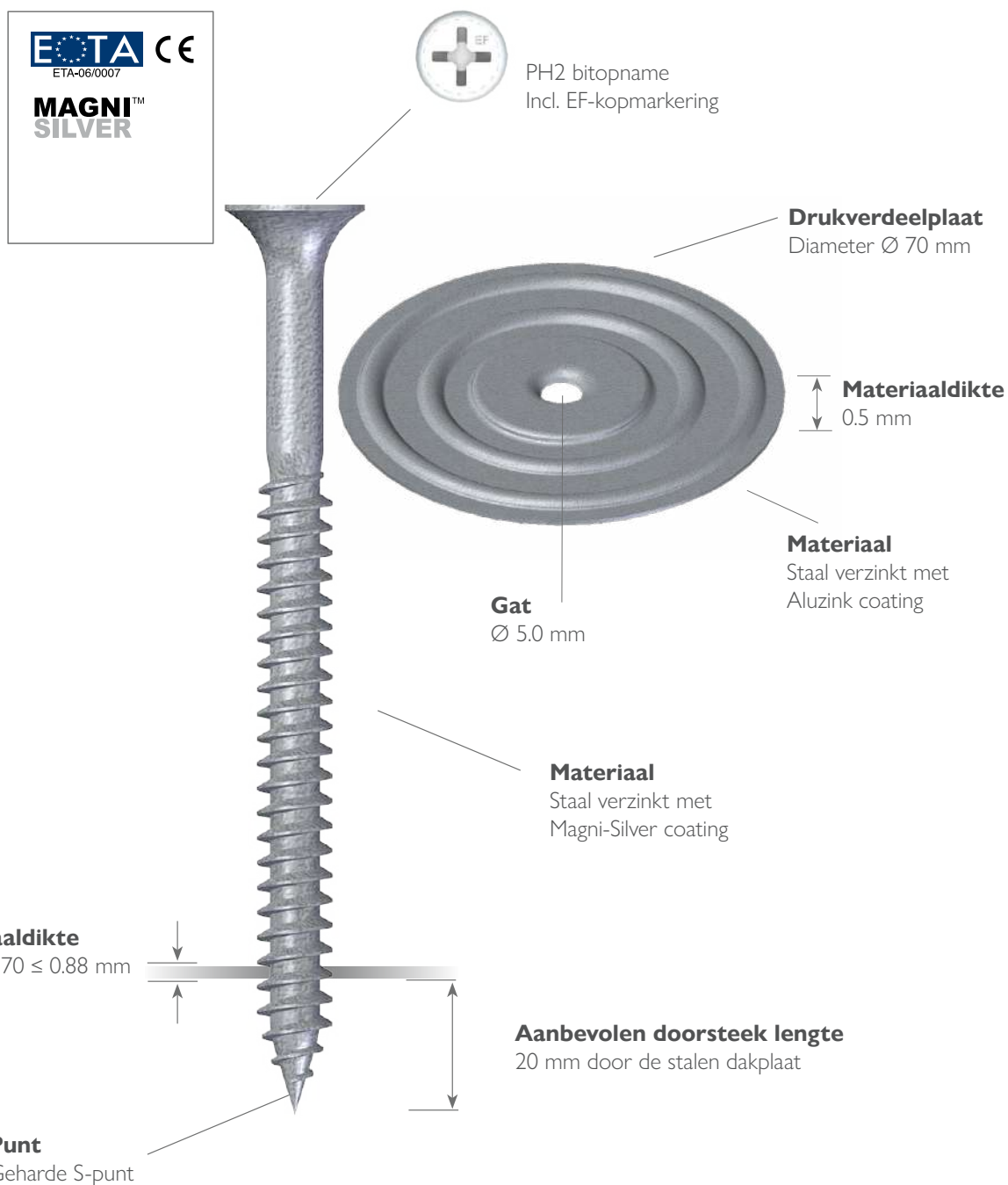

Stalen ondergrond > 0.70 ≤ 0.88 mm

Product key	Afmetingen			
	Ø	Schroef	Draad	☒
CP-PP-48050	4.8	50	45	250
CP-PP-48060	4.8	60	50	250
CP-PP-48070	4.8	70	60	250
CP-PP-48080	4.8	80	70	250
CP-PP-48090	4.8	90	80	250
CP-PP-48100	4.8	100	80	250
CP-PP-48110	4.8	110	80	250
CP-PP-48120	4.8	120	80	250
CP-PP-48130	4.8	130	80	250
CP-PP-48140	4.8	140	80	250
CP-PP-48150	4.8	150	80	250
CP-PP-48160	4.8	160	80	250
CP-PP-48170	4.8	170	80	250
CP-PP-48180	4.8	180	80	250
CP-PP-48200	4.8	200	80	250
CP-PP-48220	4.8	220	80	250

Stalen ondergrond ≤ max 2 x 1.25 mm

EUROFAST® EDS-B-5.5

30-CYCLI KESTERNICH



Torx 25 bitopname
Incl. EF-kopmarkering

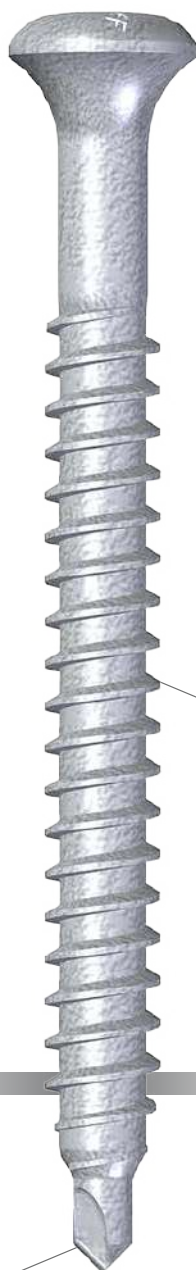

Staaldikte
≤ max 2 x 1.25 mm

Punt
Gereduceerde boorpunt

Materiaal
Staal verzinkt met
Magni-Silver coating

Aanbevolen doorsteek lengte
20 mm door de stalen dakplaat

Stalen ondergrond ≤ max 2 x 1.25 mm

Product key	Afmetingen			
	Ø	Schroef	Draad	⊠
EDS-B-55050	5.5	50	45	1000
EDS-B-55060	5.5	60	55	1000
EDS-B-55070	5.5	70	65	1000
EDS-B-55080	5.5	80	75	1000
EDS-B-55090	5.5	90	80	1000
EDS-B-55100	5.5	100	80	500
EDS-B-55120	5.5	120	80	500
EDS-B-55140	5.5	140	80	500
EDS-B-55160	5.5	160	80	500
EDS-B-55180	5.5	180	80	500
EDS-B-55210	5.5	210	80	500

Stalen ondergrond ≤ max 2 x 1.25 mm

OMG RS - DFDS-5.5

30-CYCLI KESTERNICH



PH3 bitopname

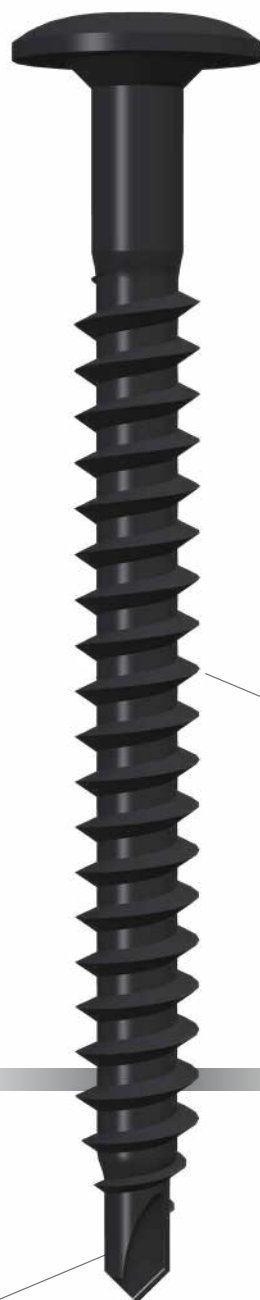

Materiaal

Staal verzinkt met
CR-10 coating

Staaldikte
≤ max 2 x 1.25 mm

Punt
Gereduceerde boorpunt

Aanbevolen doorsteek lengte
20 mm door de stalen dakplaat

Stalen ondergrond ≤ max 2 x 1.25 mm

Product key	Afmetingen			
	Ø	Schroef	Draad	⊠
DFDS-55040	5.5	40	40	1000
DFDS-55055	5.5	55	55	1000
DFDS-55075	5.5	75	75	1000
DFDS-55095	5.5	100	75	1000
DFDS-55125	5.5	125	75	1000
DFDS-55150	5.5	150	100	1000
DFDS-55175	5.5	175	100	1000
DFDS-55200	5.5	200	100	1000

Stalen ondergrond ≤ max 2 x 1.25 mm

EUROFAST® DFHD

30-CYCLI KESTERNICH

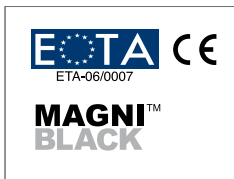

Staaldikte
0.70 - 0.88 mm
Aluminium
≥ 0.63 mm

Punt
Gereduceerde boorpunt

Coating
Magni-Black



PH3 bitopname

**Aanbevolen
doorsteek lengte**
20 mm door de
stalen dakplaat

OMG XHD - DFHD

30-CYCLI KESTERNICH



Staaldikte
≤ max 2 x 1.25 mm

Punt
Gereduceerde boorpunt

Coating
CR-10



PH3 bitopname

**Aanbevolen
doorsteek lengte**
20 mm door de
stalen dakplaat

Stalen ondergrond ≤ max 2 x 1.25 mm

Product key	Afmetingen			
	Ø	Schroef	Draad	☒
DFHD-67032	6.7	32	32	1000

Product key	Afmetingen			
	Ø	Schroef	Draad	☒
DFHD-67050	6.7	50	50	1000
DFHD-67075	6.7	75	75	1000
DFHD-67100	6.7	100	75	1000
DFHD-67125	6.7	125	100	500
DFHD-67150	6.7	150	100	500
DFHD-67175	6.7	175	100	500
DFHD-67200	6.7	200	100	500
DFHD-67225	6.7	230	100	500
DFHD-67250	6.7	255	100	500
DFHD-67275	6.7	280	100	500
DFHD-67300	6.7	305	100	500
DFHD-67350	6.7	355	100	250
DFHD-67410	6.7	405	100	250
DFHD-67460	6.7	455	100	250
DFHD-67510	6.7	510	100	250
DFHD-67560	6.7	560	100	125

Durisolmevriet

Voor mechanische bevestiging op durisolmevriet adviseren wij je te allen tijde een pull-out test uit te laten voeren. Onze vertegenwoordigers testen voor jou kostenloos op locatie.

Neem contact met ons op **+31 493 31 58 85** of mail naar sales@eurofastgroup.com voor meer informatie.

Voorboren durisolmevriet

Boordiameter Ø 5.0 of 5.5 mm gebruiken om voor te boren. De boordiameter is afhankelijk van de kwaliteit van het beton. Boordiepte: Minimaal 10 mm dieper boren dan de lengte van de bevestiging.

Stalen ondergrond ≤ max 2 x 1.25 mm

EUROFAST® EDS-SRB

BI-METAAL (RVS A4)



Torx 25 bitopname
Incl. EF-kopmarkering



Materiaal
Bi-metaal (RVS A4)

Staaldikte
≤ max 2 x 1.25 mm

Punt
Gereduceerde boorpunt

Aanbevolen doorsteek lengte
20 mm door de stalen dakplaat

Stalen ondergrond ≤ max 2 x 1.25 mm

Product key	Afmetingen			
	Ø	Schroef	Draad	☒
EDS-SRB48060	4.8	60	50	500
EDS-SRB48080	4.8	80	50	500
EDS-SRB48100	4.8	100	50	500
EDS-SRB48120	4.8	120	75	500
EDS-SRB48140	4.8	140	75	500
EDS-SRB48160	4.8	160	120	500
EDS-SRB48180	4.8	180	120	500
EDS-SRB48210	4.8	210	120	500
EDS-SRB48240	4.8	240	120	500

Stalen ondergrond ≤ max 2 x 1.25 mm

EUROFAST® EDS-BZTR

BI-METAAL (RVS A4)



Extra optie

Ook verkrijgbaar op band voor machinale verwerking

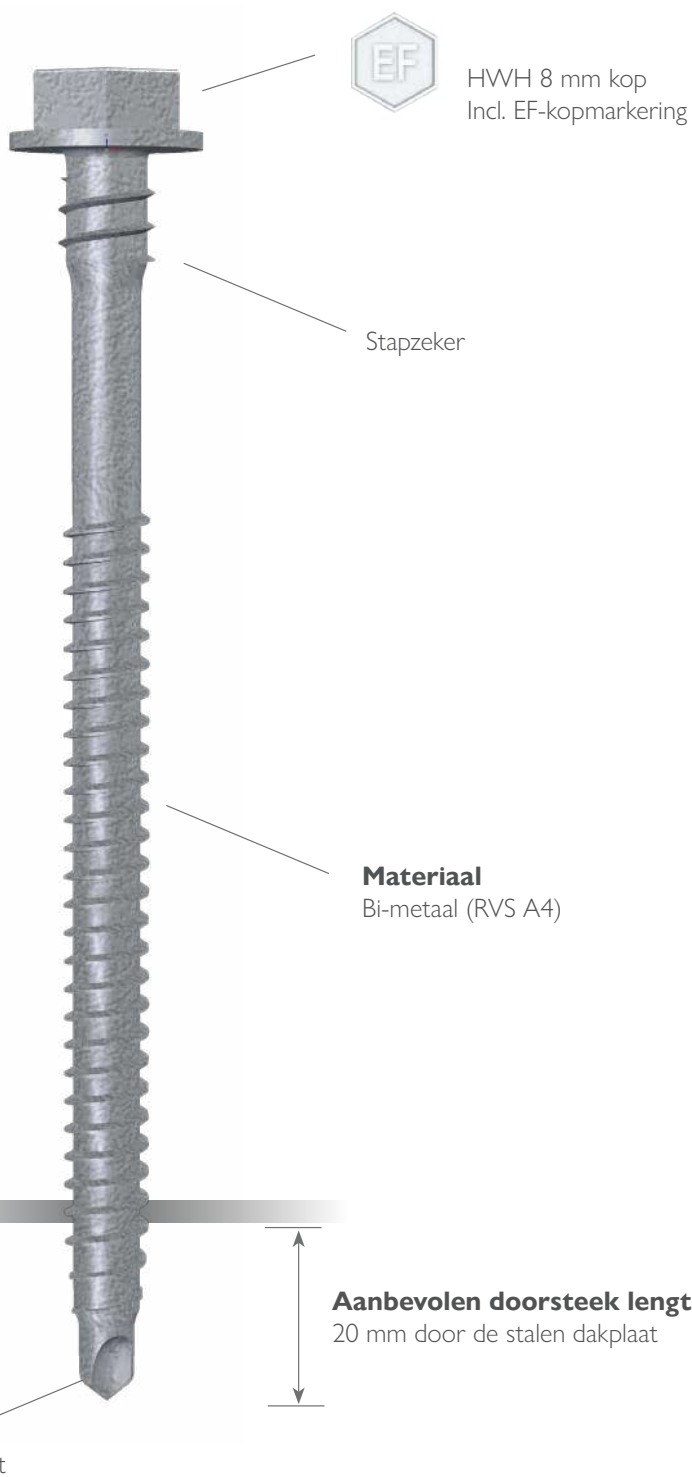

Stalen ondergrond ≤ max 2 x 1.25 mm

Product key	Afmetingen			
	Ø	Schroef	Draad	☒
EDS-BZTR48140	4.8	140	75	500
EDS-BZTR48160	4.8	160	105	500
EDS-BZTR48180	4.8	180	120	500
EDS-BZTR48200	4.8	200	120	500
EDS-BZTR48220	4.8	220	120	500
EDS-BZTR48240	4.8	240	120	500

Machinale verwerking

Eurofast® DEK-FIX



Machinale verwerking

* EDS-BGTR48140	4.8	140	75	750
* EDS-BGTR48160	4.8	160	105	750
* EDS-BGTR48180	4.8	180	120	750
* EDS-BZTR48200	4.8	200	120	750
* EDS-BGTR48220	4.8	220	120	750
* EDS-BGTR48240	4.8	240	120	750

* Levertijd op aanvraag

Tule combinatie voor stalen ondergrond > 0.70 ≤ 0.88 mm

EUROFAST® TRPS-45

15-CYCLI KESTERNICH



PH2 bitopname
Incl. EF-kopmarkering



Extra optie

Ook verkrijgbaar op band voor machinale verwerking

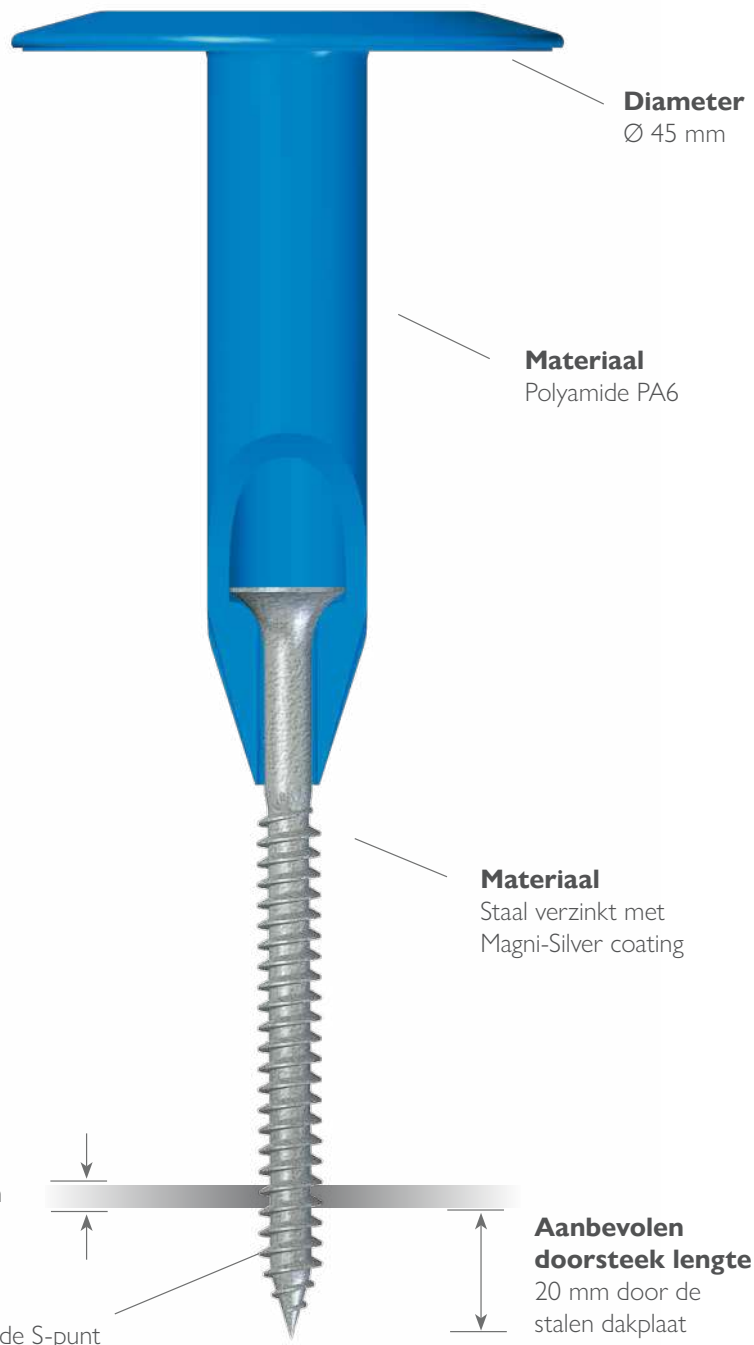

Tule combinatie voor stalen ondergrond > 0.70 ≤ 0.88 mm

Product key	Klembereik	Afmetingen			☒
	mm	Tule	Schroef		
TRPS-45-040	35 - 44	30	50	250	
TRPS-45-050	45 - 54	30	60	250	
TRPS-45-060	55 - 64	30	70	250	
TRPS-45-070	65 - 74	30	80	250	
TRPS-45-080	75 - 84	60	60	250	
TRPS-45-090	85 - 94	60	70	250	
TRPS-45-100	95 - 104	60	80	250	
TRPS-45-110	105 - 114	60	90	250	
TRPS-45-120	115 - 124	90	70	250	
TRPS-45-130	125 - 134	90	80	250	
TRPS-45-140	135 - 144	90	90	250	
TRPS-45-150	145 - 154	120	70	250	
TRPS-45-160	155 - 164	120	80	250	
TRPS-45-170	165 - 174	120	90	250	
TRPS-45-180	175 - 184	150	70	250	
TRPS-45-190	185 - 194	150	80	250	
* TRPS-45-200	195 - 204	150	90	250	
* TRPS-45-210	205 - 214	150	100	250	
* TRPS-45-220	215 - 224	150	110	250	

* Levertijd op aanvraag

Machinale verwerking

Eurofast® EURO-FIX



Machinale verwerking					
Product key	Klembereik	Afmetingen			☒
	mm	Tule	Schroef		
* TRPSG-45-040	35 - 44	30	50	1000	
* TRPSG-45-050	45 - 54	30	60	1000	
* TRPSG-45-060	55 - 64	30	70	1000	
* TRPSG-45-070	65 - 74	30	80	1000	
* TRPSG-45-080	75 - 84	60	60	1000	
* TRPSG-45-090	85 - 94	60	70	1000	
* TRPSG-45-100	95 - 104	60	80	1000	
* TRPSG-45-110	105 - 114	60	90	1000	
* TRPSG-45-120	115 - 124	90	70	1000	
* TRPSG-45-130	125 - 134	90	80	1000	
* TRPSG-45-140	135 - 144	90	90	1000	
* TRPSG-45-150	145 - 154	120	70	1000	

* Levertijd op aanvraag

Product key	Klembereik	Afmetingen			☒
	mm	Tule	Schroef		
* TRPS-45-230	225 - 234	150	120	250	
* TRPS-45-240	235 - 244	150	130	250	
* TRPS-45-250	241 - 250	225	60	250	
* TRPS-45-260	251 - 260	225	70	250	
* TRPS-45-270	261 - 270	225	80	250	
* TRPS-45-280	271 - 280	225	90	250	
* TRPS-45-290	281 - 290	225	100	250	
* TRPS-45-300	291 - 300	225	110	250	
* TRPS-45-310	301 - 310	285	60	250	
* TRPS-45-320	311 - 320	285	70	250	
* TRPS-45-330	321 - 330	285	80	250	
* TRPS-45-340	331 - 340	285	90	250	
* TRPS-45-350	341 - 350	285	100	250	
* TRPS-45-360	351 - 360	285	110	250	
* TRPS-45-370	361 - 370	285	120	250	
* TRPS-45-380	371 - 380	285	130	250	
* TRPS-45-390	381 - 390	285	140	250	
* TRPS-45-400	391 - 400	285	150	250	
* TRPS-45-410	401 - 410	285	160	250	

Rechtopstaande verwerking

Eurofast® EASYTOOL-PRO

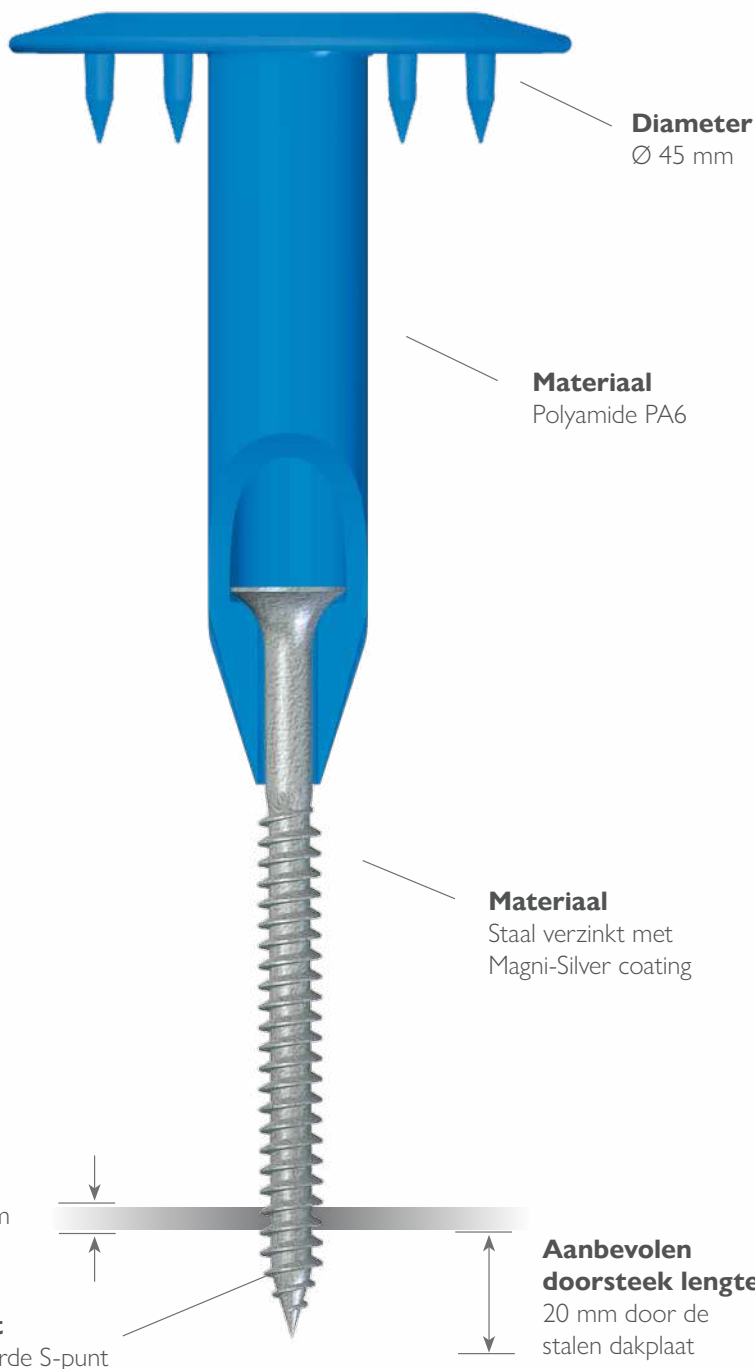

Machinale verwerking					
Product key	Klembereik	Afmetingen			☒
	mm	Tule	Schroef		
* TRPSG-45-160	155 - 164	120	80	1000	
* TRPSG-45-170	165 - 174	120	90	750	
* TRPSG-45-180	175 - 184	150	70	750	
* TRPSG-45-190	185 - 194	150	80	750	
* TRPSG-45-200	195 - 204	150	90	750	
* TRPSG-45-210	205 - 214	150	100	750	
* TRPSG-45-220	215 - 224	150	110	750	
* TRPSG-45-230	225 - 234	150	120	750	
* TRPSG-45-240	235 - 244	150	130	600	
* TRPSG-45-250	245 - 254	150	140	600	
* TRPSG-45-260	255 - 264	150	150	600	

Tule combinatie voor stalen ondergrond > 0.70 ≤ 0.88 mm**EUROFAST® BTRPS-45****15-CYCLI KESTERNICH**PH2 bitopname
Incl. EF-kopmarkering**Diameter**
Ø 45 mm**Materiaal**
Polyamide PA6**Materiaal**
Staal verzinkt met
Magni-Silver coating**Staaldikte**
> 0.70 ≤ 0.88 mm**Punt**
Geharde S-punt**Aanbevolen
doorsteek lengte**
20 mm door de
stalen dakplaat

Tule combinatie voor stalen ondergrond > 0.70 ≤ 0.88 mm

Product key	Klembereik	Afmetingen		
	mm	Tule	Schroef	⊠
BTRPS-45-040	35 - 44	30	50	250
BTRPS-45-050	45 - 54	30	60	250
BTRPS-45-060	55 - 64	30	70	250
BTRPS-45-070	65 - 74	30	80	250
BTRPS-45-080	75 - 84	60	60	250
BTRPS-45-090	85 - 94	60	70	250
BTRPS-45-100	95 - 104	60	80	250
BTRPS-45-110	105 - 114	60	90	250
BTRPS-45-120	115 - 124	90	70	250
BTRPS-45-130	125 - 134	90	80	250
BTRPS-45-140	135 - 144	90	90	250

Product key	Klembereik	Afmetingen		
	mm	Tule	Schroef	⊠
BTRPS-45-150	145 - 154	120	70	250
BTRPS-45-160	155 - 164	120	80	250
BTRPS-45-170	165 - 174	120	90	250
BTRPS-45-180	175 - 184	150	70	250
BTRPS-45-190	185 - 194	150	80	250
* BTRPS-45-200	195 - 204	150	90	250
* BTRPS-45-210	205 - 214	150	100	250
* BTRPS-45-220	215 - 224	150	110	250
* BTRPS-45-230	225 - 234	150	120	250
* BTRPS-45-240	235 - 244	150	130	250

* Levertijd op aanvraag

Rechtopstaande verwerking

Eurofast® EASYTOOL-PRO



Tule combinatie voor stalen ondergrond > 0.70 ≤ 0.88 mm

EUROFAST® TWPS-8040

15-CYCLI KESTERNICH



PH2 bitopname
Incl. EF-kopmarkering



Extra optie

Ook verkrijgbaar op band voor machinale verwerking

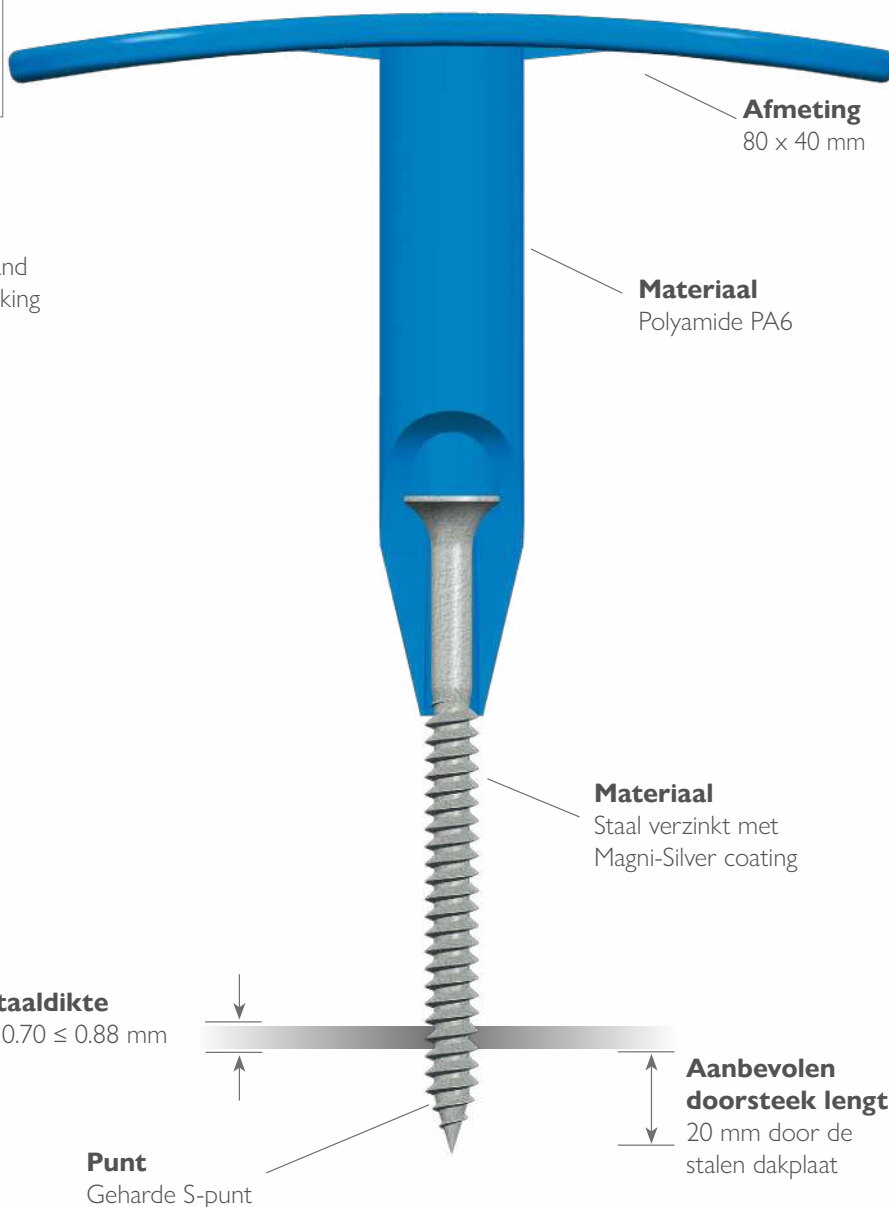

Tule combinatie voor stalen ondergrond > 0.70 ≤ 0.88 mm

Product key	Klembereik	Afmetingen			☒
	mm	Tule	Schroef		
* TWPS-8040-040	31 - 44	30	50	250	
* TWPS-8040-050	45 - 54	30	60	250	
* TWPS-8040-060	55 - 64	30	70	250	
* TWPS-8040-070	65 - 74	30	80	250	
* TWPS-8040-080	75 - 84	60	60	250	
* TWPS-8040-090	85 - 94	60	70	250	
* TWPS-8040-100	95 - 104	60	80	250	
* TWPS-8040-110	105 - 114	60	90	250	
* TWPS-8040-120	115 - 124	90	70	250	
* TWPS-8040-130	125 - 134	90	80	250	
* TWPS-8040-140	135 - 144	90	90	250	
* TWPS-8040-150	145 - 154	120	70	250	
* TWPS-8040-160	155 - 164	120	80	250	
* TWPS-8040-170	165 - 174	120	90	250	
* TWPS-8040-180	175 - 184	150	70	250	
* TWPS-8040-190	185 - 194	150	80	250	

Product key	Klembereik	Afmetingen			☒
	mm	Tule	Schroef		
* TWPS-8040-200	195 - 204	150	90	250	
* TWPS-8040-210	205 - 214	150	100	250	
* TWPS-8040-220	215 - 224	150	110	250	
* TWPS-8040-230	225 - 234	150	120	250	
* TWPS-8040-240	235 - 244	150	130	250	
* TWPS-8040-250	245 - 254	150	140	250	
* TWPS-8040-260	255 - 264	150	150	250	
* TWPS-8040-270	265 - 274	150	160	250	
* TWPS-8040-280	275 - 284	150	170	250	
* TWPS-8040-290	285 - 294	150	180	250	
* TWPS-8040-310	295 - 314	150	200	250	
* TWPS-8040-330	315 - 334	150	220	250	
* TWPS-8040-350	335 - 354	150	240	250	
* TWPS-8040-370	355 - 374	150	260	250	
* TWPS-8040-390	375 - 394	150	280	250	
* TWPS-8040-410	395 - 414	150	300	250	

* Levertijd op aanvraag

Machinale verwerking

Eurofast® EURO-FIX



Rechtopstaande verwerking

Eurofast® EASYTOOL-PRO



Machinale verwerking					
Product key	Klembereik	Afmetingen			☒
	mm	Tule	Schroef		
* TWPSG-8040-040	31 - 44	30	50	750	
* TWPSG-8040-050	45 - 54	30	60	750	
* TWPSG-8040-060	55 - 64	30	70	750	
* TWPSG-8040-070	65 - 74	30	80	750	
* TWPSG-8040-080	75 - 84	60	60	750	
* TWPSG-8040-090	85 - 94	60	70	750	
* TWPSG-8040-100	95 - 104	60	80	750	
* TWPSG-8040-110	105 - 114	60	90	750	
* TWPSG-8040-120	115 - 124	90	70	750	
* TWPSG-8040-130	125 - 134	90	80	750	
* TWPSG-8040-140	135 - 144	90	90	750	
* TWPSG-8040-150	145 - 154	120	70	750	

Machinale verwerking					
Product key	Klembereik	Afmetingen			☒
	mm	Tule	Schroef		
* TWPSG-8040-160	155 - 164	120	80	750	
* TWPSG-8040-170	165 - 174	120	90	600	
* TWPSG-8040-180	175 - 184	150	70	600	
* TWPSG-8040-190	185 - 194	150	80	600	
* TWPSG-8040-200	195 - 204	150	90	600	
* TWPSG-8040-210	205 - 214	150	100	600	
* TWPSG-8040-220	215 - 224	150	110	600	
* TWPSG-8040-230	225 - 234	150	120	600	
* TWPSG-8040-240	235 - 244	150	130	450	
* TWPSG-8040-250	245 - 254	150	140	450	
* TWPSG-8040-260	255 - 264	150	150	450	

* Levertijd op aanvraag

Tule combinatie voor stalen ondergrond > 0.70 ≤ 0.88 mm

EUROFAST® TLKS-45

15-CYCLI KESTERNICH



PH2 bitopname
Incl. EF-kopmarkering

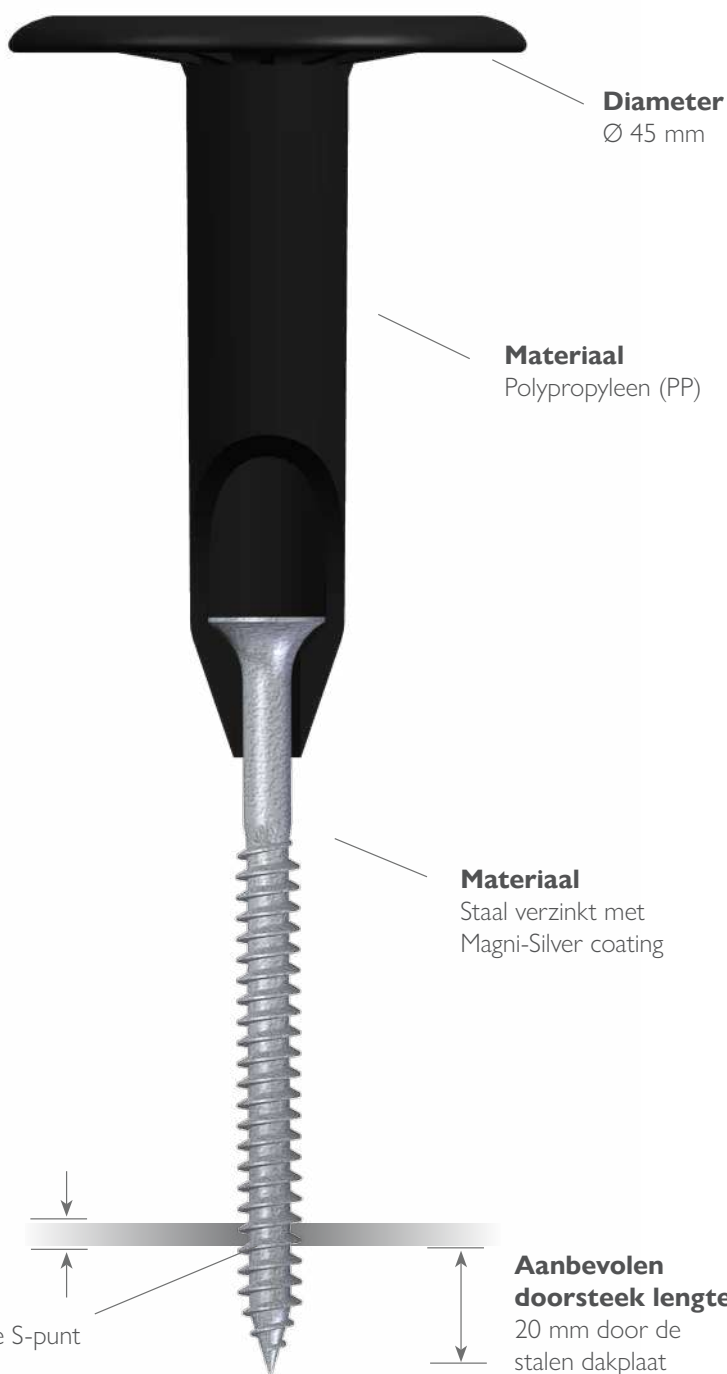

Tule combinatie voor stalen ondergrond > 0.70 ≤ 0.88 mm

Product key	Klembereik	Afmetingen			Product key	Klembereik	Afmetingen		
	mm	Tule	Schroef	⊠		mm	Tule	Schroef	⊠
* TLKS-45-050	45 - 54	35	60	250	* TLKS-45-250	245 - 254	225	70	125
* TLKS-45-060	55 - 64	35	70	250	* TLKS-45-260	255 - 264	225	80	125
* TLKS-45-070	65 - 74	35	80	250	* TLKS-45-270	265 - 274	225	90	125
* TLKS-45-080	75 - 84	35	90	250	* TLKS-45-280	275 - 284	255	70	125
* TLKS-45-090	85 - 94	65	70	250	* TLKS-45-290	285 - 294	255	80	125
* TLKS-45-100	95 - 104	65	80	250	* TLKS-45-300	295 - 304	255	90	125
* TLKS-45-110	105 - 114	85	70	250	* TLKS-45-320	305 - 324	285	80	125
* TLKS-45-120	115 - 124	85	80	250	* TLKS-45-340	325 - 344	285	100	125
* TLKS-45-130	125 - 134	105	70	250	* TLKS-45-360	345 - 364	320	90	125
TLKS-45-140	135 - 144	105	80	250	* TLKS-45-380	365 - 384	320	110	125
TLKS-45-150	145 - 154	105	90	250	* TLKS-45-400	385 - 404	320	130	125
TLKS-45-160	155 - 164	135	70	250	* TLKS-45-420	405 - 424	320	150	125
* TLKS-45-170	165 - 174	135	80	250	* TLKS-45-440	425 - 444	320	170	125
* TLKS-45-180	175 - 184	135	90	250	* TLKS-45-450	445 - 454	320	180	125
* TLKS-45-190	185 - 194	165	70	250	* TLKS-45-470	455 - 474	320	200	125
TLKS-45-200	195 - 204	165	80	250	* TLKS-45-490	475 - 494	320	220	125
* TLKS-45-210	205 - 214	185	70	250	* TLKS-45-510	495 - 514	320	240	125
* TLKS-45-220	215 - 224	185	80	250	* TLKS-45-530	515 - 534	320	260	125
* TLKS-45-230	225 - 234	185	90	250	* TLKS-45-550	535 - 554	320	280	125
* TLKS-45-240	235 - 244	185	100	250	* TLKS-45-570	555 - 574	320	300	125

* Levertijd op aanvraag

Rechtopstaande verwerking

Eurofast® EASYTOOL-PRO



Tule combinatie voor stalen ondergrond > 0.70 ≤ 0.88 mm

EUROFAST® TLKS-75

15-CYCLI KESTERNICH



PH2 bitopname
Incl. EF-kopmarkering

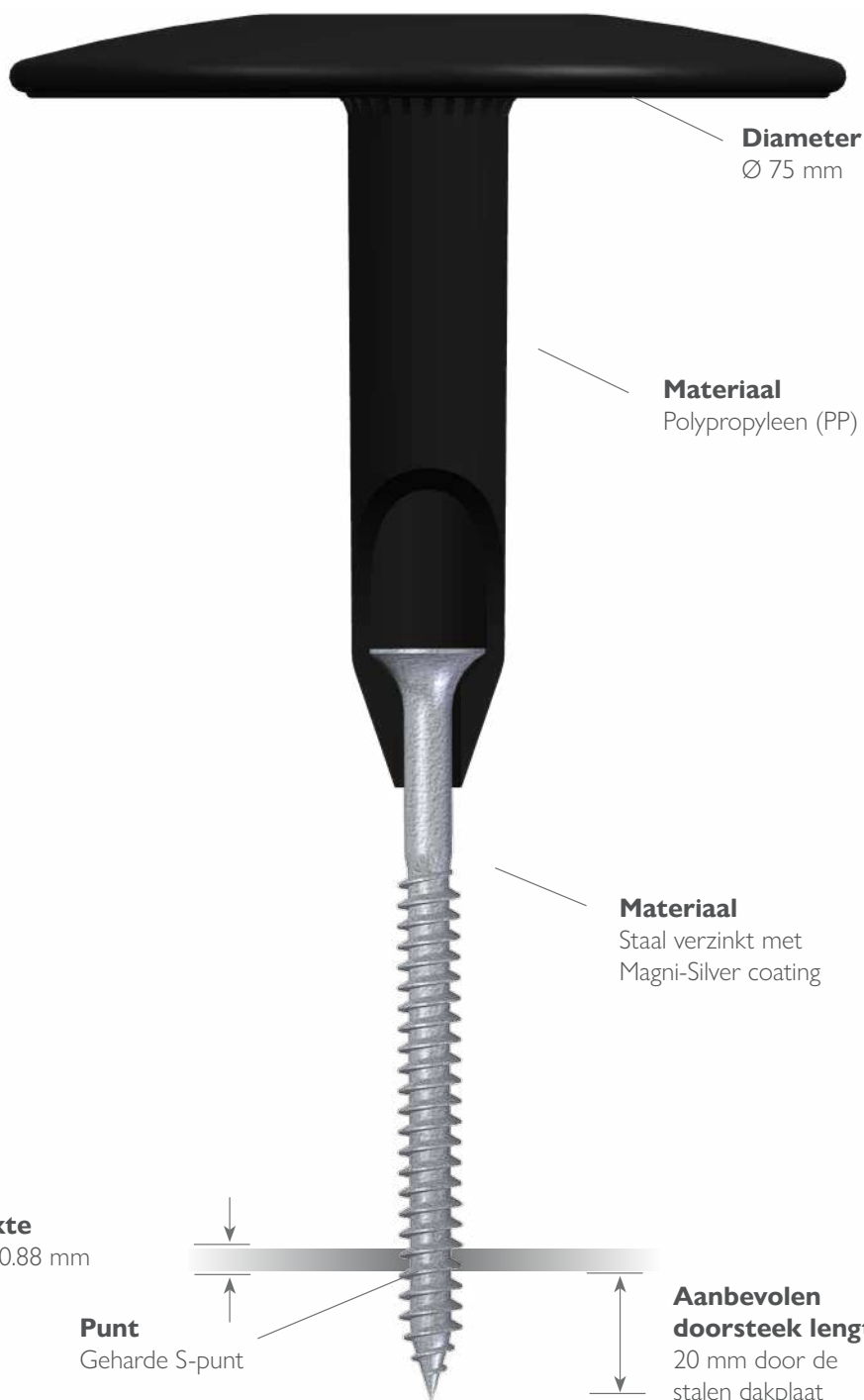

Diameter
Ø 75 mm

Materiaal
Polypropyleen (PP)

Materiaal
Staal verzinkt met
Magni-Silver coating

Staaldikte
> 0.70 ≤ 0.88 mm

Punt
Geharde S-punt

**Aanbevolen
doorsteek lengte**
20 mm door de
stalen dakplaat

Tule combinatie voor stalen ondergrond > 0.70 ≤ 0.88 mm

Product key	Klembereik	Afmetingen			☒
	mm	Tule	Schroef		
* TLKS-75-050	45 - 54	35	60	250	
TLKS-75-060	55 - 64	35	70	250	
TLKS-75-070	65 - 74	35	80	250	
TLKS-75-080	75 - 84	35	90	250	
TLKS-75-090	85 - 94	65	70	250	
TLKS-75-100	95 - 104	65	80	250	
TLKS-75-110	105 - 114	85	70	250	
TLKS-75-120	115 - 124	85	80	250	
TLKS-75-130	125 - 134	105	70	250	
TLKS-75-140	135 - 144	105	80	250	
TLKS-75-150	145 - 154	105	90	250	
TLKS-75-160	155 - 164	135	70	125	
TLKS-75-170	165 - 174	135	80	125	
TLKS-75-180	175 - 184	135	90	125	
TLKS-75-190	185 - 194	165	70	125	
TLKS-75-200	195 - 204	165	80	125	
TLKS-75-210	205 - 214	185	70	125	

Product key	Klembereik	Afmetingen			☒
	mm	Tule	Schroef		
TLKS-75-220	215 - 224	185	80	125	
TLKS-75-230	225 - 234	185	90	125	
TLKS-75-240	235 - 244	185	100	125	
* TLKS-75-250	245 - 254	185	110	125	
* TLKS-75-260	255 - 264	185	120	125	
* TLKS-75-270	265 - 274	185	130	125	
* TLKS-75-280	275 - 284	185	140	125	
* TLKS-75-290	285 - 294	185	150	125	
* TLKS-75-300	295 - 304	185	160	125	
* TLKS-75-310	305 - 314	185	170	125	
* TLKS-75-320	315 - 324	185	180	125	
* TLKS-75-340	325 - 344	185	200	125	
* TLKS-75-360	345 - 364	185	220	125	
* TLKS-75-380	365 - 384	185	240	125	
* TLKS-75-400	385 - 404	185	260	125	
* TLKS-75-420	405 - 424	185	280	125	
* TLKS-75-440	425 - 444	185	300	125	

* Levertijd op aanvraag

Rechtopstaande verwerking

Eurofast® EASYTOOL-PRO



Tule combinatie voor stalen ondergrond ≤ max 2 x 1.25 mm

EUROFAST® TRPB-45

15-CYCLI KESTERNICH



Torx 25 bitopname
Incl. EF-kopmarkering



Extra optie

Ook verkrijgbaar op band voor machinale verwerking

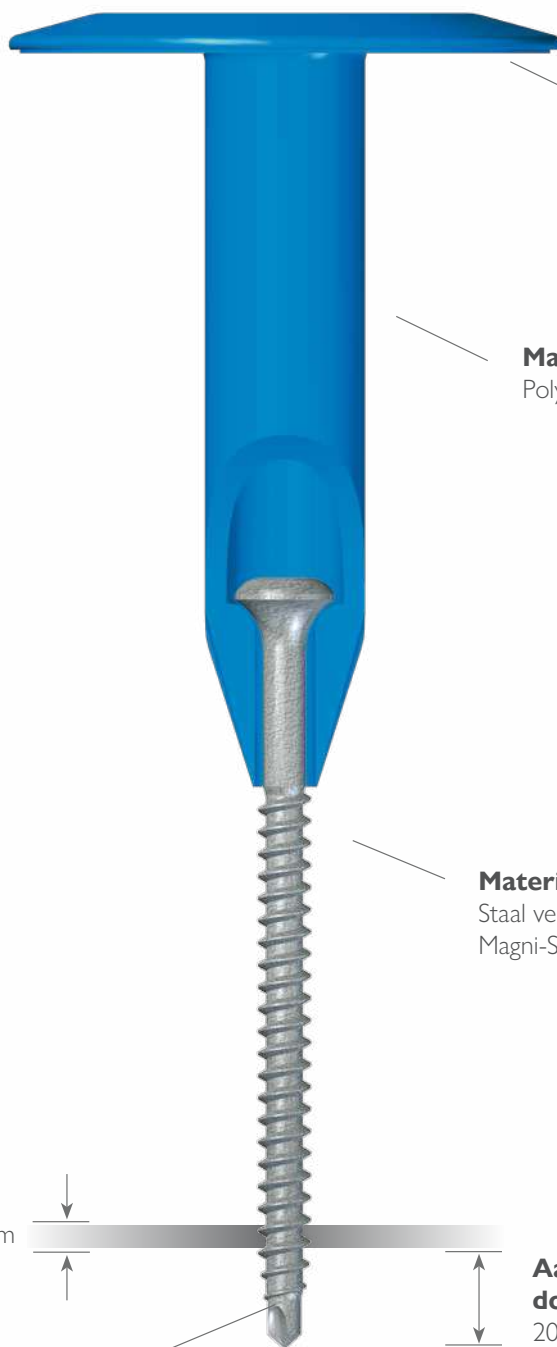

Diameter
Ø 45 mm

Materiaal
Polyamide PA6

Materiaal
Staal verzinkt met
Magni-Silver coating

Staaldikte
≤ max 2 x 1.25 mm

Punt
Gereduceerde boorpunt

**Aanbevolen
doorsteek lengte**
20 mm door de
stalen dakplaat

Tule combinatie voor stalen ondergrond ≤ max 2 x 1.25 mm

Product key	Klembereik	Afmetingen		
	mm	Tule	Schroef	☒
TRPB-45-040	35 - 44	30	50	250
TRPB-45-050	45 - 54	30	60	250
TRPB-45-060	55 - 64	30	70	250
TRPB-45-070	65 - 74	30	80	250
TRPB-45-080	75 - 84	60	60	250
TRPB-45-090	85 - 94	60	70	250
TRPB-45-100	95 - 104	60	80	250
TRPB-45-110	105 - 114	60	90	250
TRPB-45-120	115 - 124	90	70	250
TRPB-45-130	125 - 134	90	80	250
TRPB-45-140	135 - 144	90	90	250
TRPB-45-150	145 - 154	120	70	250
TRPB-45-160	155 - 164	120	80	250
TRPB-45-170	165 - 174	120	90	250
TRPB-45-180	175 - 184	150	70	250
TRPB-45-190	185 - 194	150	80	250
TRPB-45-200	195 - 204	150	90	250
TRPB-45-210	205 - 214	150	100	250
TRPB-45-220	215 - 224	150	110	250

Product key	Klembereik	Afmetingen		
	mm	Tule	Schroef	☒
TRPB-45-230	225 - 234	150	120	250
TRPB-45-240	235 - 244	150	130	250
TRPB-45-250	241 - 250	225	60	250
TRPB-45-260	251 - 260	225	70	250
TRPB-45-270	261 - 270	225	80	250
TRPB-45-280	271 - 280	225	90	250
TRPB-45-290	281 - 290	225	100	250
TRPB-45-300	291 - 300	225	110	250
TRPB-45-310	301 - 310	285	60	250
TRPB-45-320	311 - 320	285	70	250
TRPB-45-330	321 - 330	285	80	250
TRPB-45-340	331 - 340	285	90	250
TRPB-45-350	341 - 350	285	100	250
TRPB-45-360	351 - 360	285	110	250
TRPB-45-370	361 - 370	285	120	250
TRPB-45-380	371 - 380	285	130	250
TRPB-45-390	381 - 390	285	140	250
TRPB-45-400	391 - 400	285	150	250

Machinale verwerking

Eurofast® EURO-FIX



Rechtopstaande verwerking

Eurofast® EASYTOOL-PRO



Machinale verwerking				
Product key	Klembereik	Afmetingen		
	mm	Tule	Schroef	☒
TRPBG-45-040	35 - 44	30	50	1000
TRPBG-45-050	45 - 54	30	60	1000
TRPBG-45-060	55 - 64	30	70	1000
TRPBG-45-070	65 - 74	30	80	1000
TRPBG-45-080	75 - 84	60	60	1000
TRPBG-45-090	85 - 94	60	70	1000
TRPBG-45-100	95 - 104	60	80	1000
TRPBG-45-110	105 - 114	60	90	1000
TRPBG-45-120	115 - 124	90	70	1000
TRPBG-45-130	125 - 134	90	80	1000
TRPBG-45-140	135 - 144	90	90	1000
TRPBG-45-150	145 - 154	120	70	1000

Machinale verwerking				
Product key	Klembereik	Afmetingen		
	mm	Tule	Schroef	☒
TRPBG-45-160	155 - 164	120	80	1000
TRPBG-45-170	165 - 174	120	90	750
TRPBG-45-180	175 - 184	150	70	750
TRPBG-45-190	185 - 194	150	80	750
TRPBG-45-200	195 - 204	150	90	750
TRPBG-45-210	205 - 214	150	100	750
TRPBG-45-220	215 - 224	150	110	750
TRPBG-45-230	225 - 234	150	120	750
TRPBG-45-240	235 - 244	150	130	600
TRPBG-45-250	245 - 254	150	140	600
TRPBG-45-260	255 - 264	150	150	600

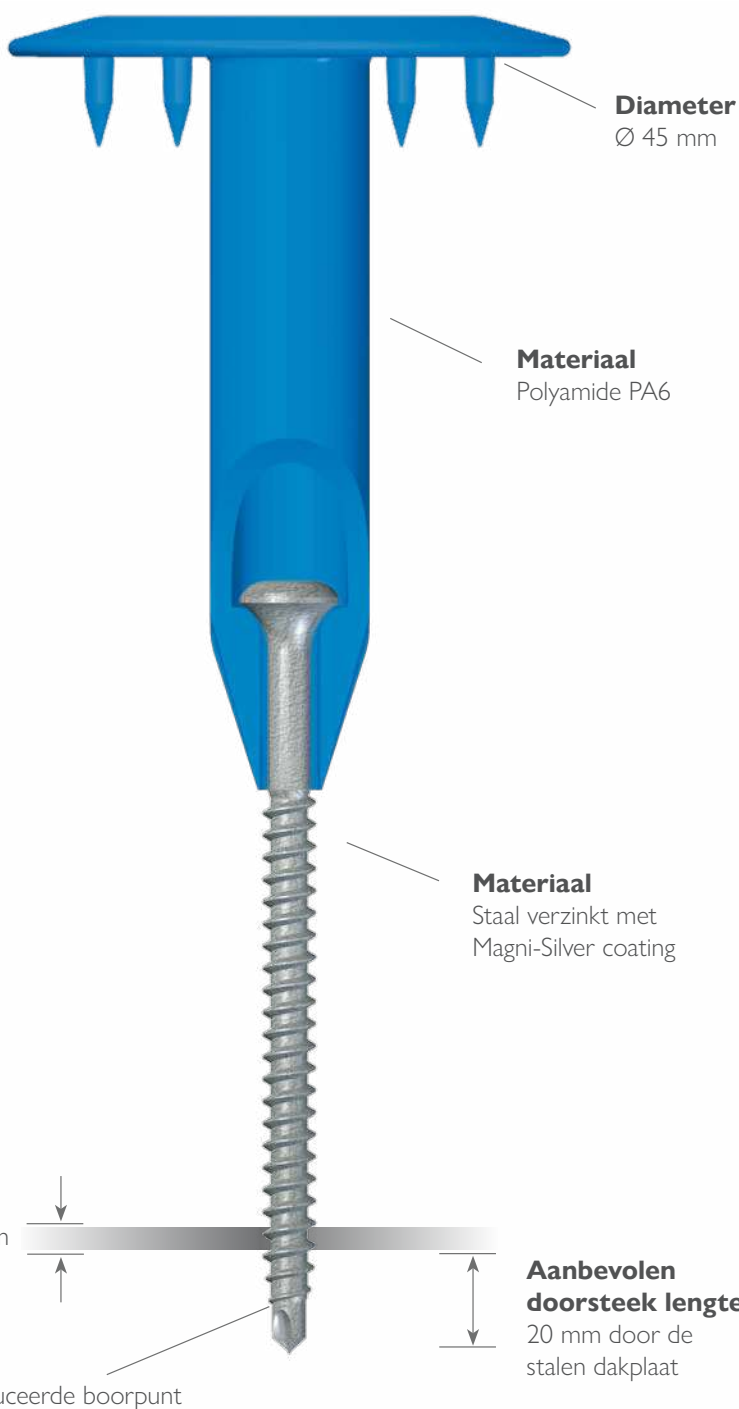
Tule combinatie voor stalen ondergrond ≤ max 2 x 1.25 mm**EUROFAST® BTRPB-45****15-CYCLI KESTERNICH**Torx 25 bitopname
Incl. EF-kopmarkering

Tule combinatie voor stalen ondergrond ≤ max 2 x 1.25 mm

Product key	Klembereik	Afmetingen		
	mm	Tule	Schroef	⊠
BTRPB-45-040	35 - 44	30	50	250
BTRPB-45-050	45 - 54	30	60	250
BTRPB-45-060	55 - 64	30	70	250
BTRPB-45-070	65 - 74	30	80	250
BTRPB-45-080	75 - 84	60	60	250
BTRPB-45-090	85 - 94	60	70	250
BTRPB-45-100	95 - 104	60	80	250
BTRPB-45-110	105 - 114	60	90	250
BTRPB-45-120	115 - 124	90	70	250
BTRPB-45-130	125 - 134	90	80	250
BTRPB-45-140	135 - 144	90	90	250

Product key	Klembereik	Afmetingen		
	mm	Tule	Schroef	⊠
BTRPB-45-150	145 - 154	120	70	250
BTRPB-45-160	155 - 164	120	80	250
BTRPB-45-170	165 - 174	120	90	250
BTRPB-45-180	175 - 184	150	70	250
BTRPB-45-190	185 - 194	150	80	250
BTRPB-45-200	195 - 204	150	90	250
BTRPB-45-210	205 - 214	150	100	250
BTRPB-45-220	215 - 224	150	110	250
BTRPB-45-230	225 - 234	150	120	250
BTRPB-45-240	235 - 244	150	130	250

Rechtopstaande verwerking

Eurofast® EASYTOOL-PRO



Tule combinatie voor stalen ondergrond ≤ max 2 x 1.25 mm

EUROFAST® TWPB-8040

15-CYCLI KESTERNICH



Torx 25 bitopname
Incl. EF-kopmarkering

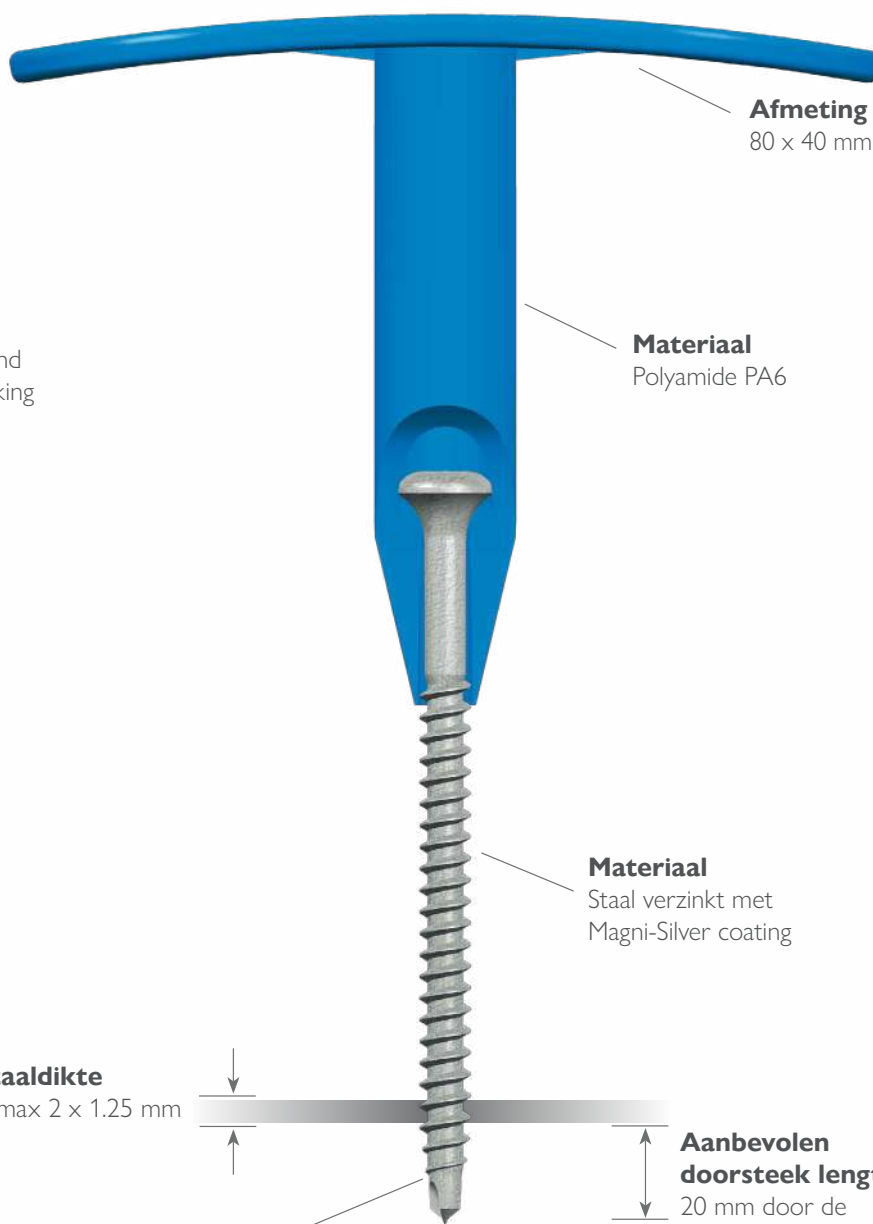

Extra optie

Ook verkrijgbaar op band
voor machinale verwerking



Tule combinatie voor stalen ondergrond ≤ max 2 x 1.25 mm

Product key	Klembereik	Afmetingen			☒
	mm	Tule	Schroef		
* TWPB-8040-040	31 - 44	30	50	250	
* TWPB-8040-050	45 - 54	30	60	250	
* TWPB-8040-060	55 - 64	30	70	250	
* TWPB-8040-070	65 - 74	30	80	250	
* TWPB-8040-080	75 - 84	60	60	250	
* TWPB-8040-090	85 - 94	60	70	250	
* TWPB-8040-100	95 - 104	60	80	250	
* TWPB-8040-110	105 - 114	60	90	250	
* TWPB-8040-120	115 - 124	90	70	250	
* TWPB-8040-130	125 - 134	90	80	250	
* TWPB-8040-140	135 - 144	90	90	250	
* TWPB-8040-150	145 - 154	120	70	250	
* TWPB-8040-160	155 - 164	120	80	250	
* TWPB-8040-170	165 - 174	120	90	250	
* TWPB-8040-180	175 - 184	150	70	250	

Product key	Klembereik	Afmetingen			☒
	mm	Tule	Schroef		
* TWPB-8040-190	185 - 194	150	80	250	
* TWPB-8040-200	195 - 204	150	90	250	
* TWPB-8040-210	205 - 214	150	100	250	
* TWPB-8040-220	215 - 224	150	110	250	
* TWPB-8040-230	225 - 234	150	120	250	
* TWPB-8040-240	235 - 244	150	130	250	
* TWPB-8040-250	245 - 254	150	140	250	
* TWPB-8040-260	255 - 264	150	150	250	
* TWPB-8040-290	265 - 284	150	180	250	
* TWPB-8040-320	285 - 324	150	210	250	
* TWPB-8040-350	325 - 354	150	240	250	
* TWPB-8040-370	355 - 374	150	260	250	
* TWPB-8040-390	375 - 394	150	280	250	
* TWPB-8040-410	395 - 414	150	300	250	

* Levertijd op aanvraag

Machinale verwerking

Eurofast® EURO-FIX



Rechtopstaande verwerking

Eurofast® EASYTOOL-PRO



Machinale verwerking					
Product key	Klembereik	Afmetingen			☒
	mm	Tule	Schroef		
* TWPBG-8040-040	31 - 44	30	50	750	
* TWPBG-8040-050	45 - 54	30	60	750	
* TWPBG-8040-060	55 - 64	30	70	750	
* TWPBG-8040-070	65 - 74	30	80	750	
* TWPBG-8040-080	75 - 84	60	60	750	
* TWPBG-8040-090	85 - 94	60	70	750	
* TWPBG-8040-100	95 - 104	60	80	750	
* TWPBG-8040-110	105 - 114	60	90	750	
* TWPBG-8040-120	115 - 124	90	70	750	
* TWPBG-8040-130	125 - 134	90	80	750	
* TWPBG-8040-140	135 - 144	90	90	750	
* TWPBG-8040-150	145 - 154	120	70	750	

Machinale verwerking					
Product key	Klembereik	Afmetingen			☒
	mm	Tule	Schroef		
* TWPBG-8040-160	155 - 164	120	80	750	
* TWPBG-8040-170	165 - 174	120	90	600	
* TWPBG-8040-180	175 - 184	150	70	600	
* TWPBG-8040-190	185 - 194	150	80	600	
* TWPBG-8040-200	195 - 204	150	90	600	
* TWPBG-8040-210	205 - 214	150	100	600	
* TWPBG-8040-220	215 - 224	150	110	600	
* TWPBG-8040-230	225 - 234	150	120	600	
* TWPBG-8040-240	235 - 244	150	130	450	
* TWPBG-8040-250	245 - 254	150	140	450	
* TWPBG-8040-260	255 - 264	150	150	450	

* Levertijd op aanvraag

Tule combinatie voor stalen ondergrond ≤ max 2 x 1.25 mm

EUROFAST® TLKB-45

15-CYCLI KESTERNICH



Torx 25 bitopname
Incl. EF-kopmarkering

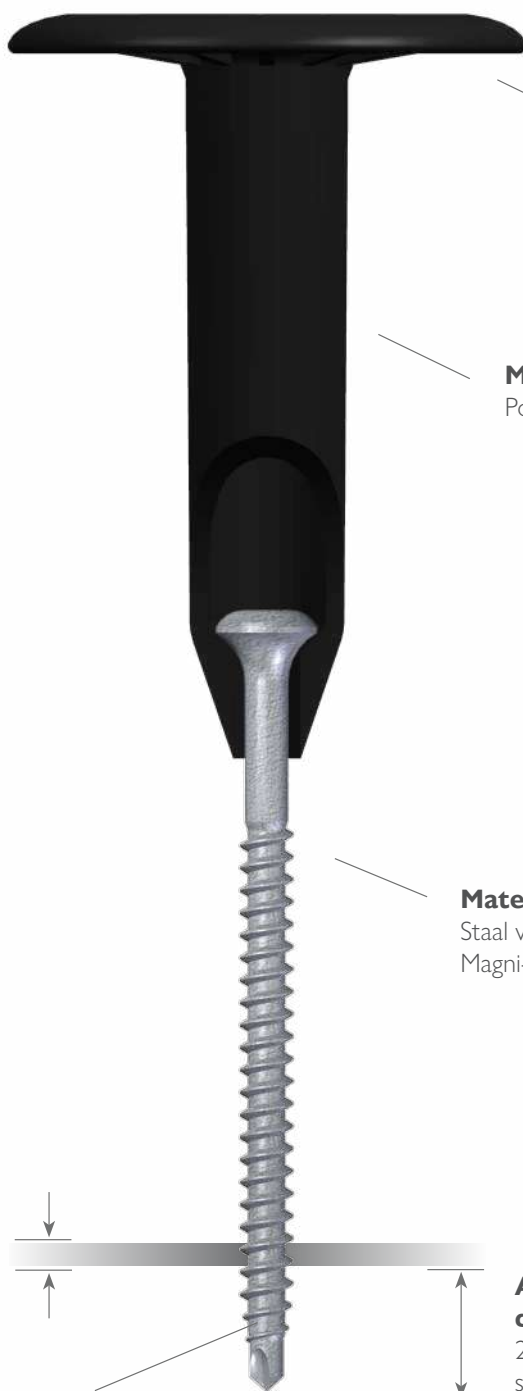

Diameter
Ø 45 mm

Materiaal
Polypropyleen (PP)

Materiaal
Staal verzinkt met
Magni-Silver coating

Staaldikte
≤ max 2 x 1.25 mm

Punt
Gereduceerde boorpunt

**Aanbevolen
doorsteek lengte**
20 mm door de
stalen dakplaat

Tule combinatie voor stalen ondergrond ≤ max 2 x 1.25 mm

Product key	Klembereik	Afmetingen			✉
	mm	Tule	Schroef		
* TLKB-45-050	45 - 54	35	60	250	
* TLKB-45-060	55 - 64	35	70	250	
* TLKB-45-070	65 - 74	35	80	250	
* TLKB-45-080	75 - 84	35	90	250	
* TLKB-45-090	85 - 94	65	70	250	
* TLKB-45-100	95 - 104	65	80	250	
* TLKB-45-110	105 - 114	85	70	250	
* TLKB-45-120	115 - 124	85	80	250	
* TLKB-45-130	125 - 134	105	70	250	
* TLKB-45-140	135 - 144	105	80	250	
* TLKB-45-150	145 - 154	105	90	250	
* TLKB-45-160	155 - 164	135	70	250	
* TLKB-45-170	165 - 174	135	80	250	
* TLKB-45-180	175 - 184	135	90	250	
* TLKB-45-190	185 - 194	165	70	250	
* TLKB-45-200	195 - 204	165	80	250	
* TLKB-45-210	205 - 214	185	70	250	
* TLKB-45-220	215 - 224	185	80	250	
* TLKB-45-230	225 - 234	185	90	250	
* TLKB-45-240	235 - 244	185	100	250	

Product key	Klembereik	Afmetingen			✉
	mm	Tule	Schroef		
* TLKB-45-250	245 - 254	225	70	125	
* TLKB-45-260	255 - 264	225	80	125	
* TLKB-45-270	265 - 274	225	90	125	
* TLKB-45-280	275 - 284	255	70	125	
* TLKB-45-290	285 - 294	255	80	125	
* TLKB-45-300	295 - 304	255	90	125	
* TLKB-45-320	305 - 324	285	80	125	
* TLKB-45-340	325 - 344	285	100	125	
* TLKB-45-360	345 - 364	320	90	125	
* TLKB-45-380	365 - 384	320	110	125	
* TLKB-45-400	385 - 404	320	130	125	
* TLKB-45-420	405 - 424	320	150	125	
* TLKB-45-440	425 - 444	320	180	125	
* TLKB-45-460	445 - 464	320	180	125	
* TLKB-45-470	465 - 474	320	210	125	
* TLKB-45-480	475 - 484	320	210	125	
* TLKB-45-510	485 - 514	320	240	125	
* TLKB-45-530	515 - 534	320	260	125	
* TLKB-45-550	535 - 554	320	280	125	
* TLKB-45-570	555 - 574	320	300	125	

* Levertijd op aanvraag

Rechtopstaande verwerking

Eurofast® EASYTOOL-PRO



Tule combinatie voor stalen ondergrond ≤ max 2 x 1.25 mm

EUROFAST® TLKB-75

15-CYCLI KESTERNICH



Torx 25 bitopname
Incl. EF-kopmarkering

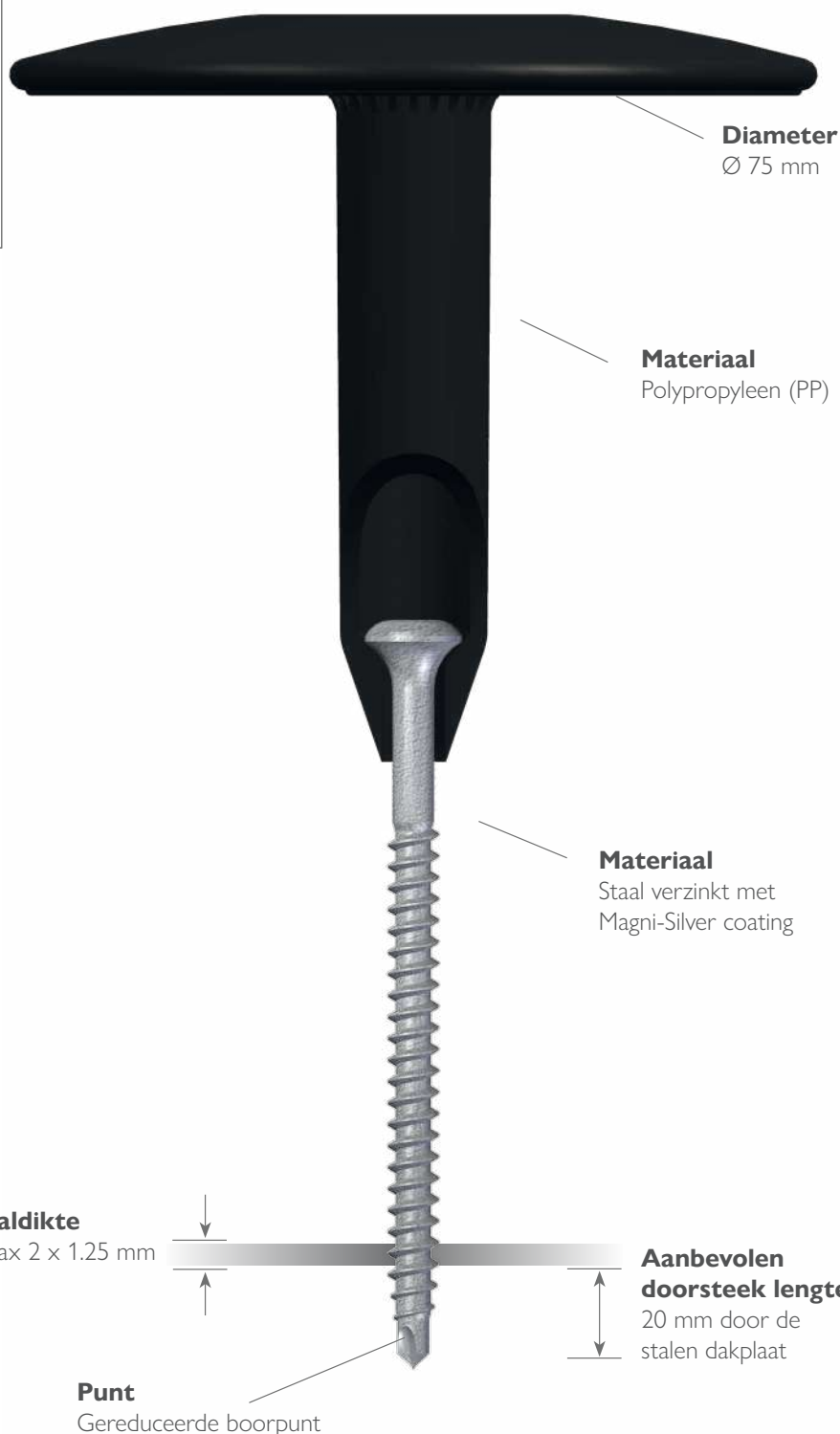

Tule combinatie voor stalen ondergrond ≤ max 2 x 1.25 mm

Product key	Klembereik	Afmetingen			☒
	mm	Tule	Schroef		
* TLKB-75-050	45 - 54	35	60	250	
* TLKB-75-060	55 - 64	35	70	250	
* TLKB-75-070	65 - 74	35	80	250	
TLKB-75-080	75 - 84	35	90	250	
* TLKB-75-090	85 - 94	65	70	250	
TLKB-75-100	95 - 104	65	80	250	
* TLKB-75-110	105 - 114	85	70	250	
TLKB-75-120	115 - 124	85	80	250	
TLKB-75-130	125 - 134	105	70	250	
TLKB-75-140	135 - 144	105	80	250	
TLKB-75-150	145 - 154	105	90	250	
TLKB-75-160	155 - 164	135	70	125	
* TLKB-75-170	165 - 174	135	80	125	
TLKB-75-180	175 - 184	135	90	125	
* TLKB-75-190	185 - 194	165	70	125	
TLKB-75-200	195 - 204	165	80	125	

Product key	Klembereik	Afmetingen			☒
	mm	Tule	Schroef		
TLKB-75-210	205 - 214	185	70	125	
TLKB-75-220	215 - 224	185	80	125	
* TLKB-75-230	225 - 234	185	90	125	
TLKB-75-240	235 - 244	185	100	125	
* TLKB-75-250	245 - 254	185	110	125	
* TLKB-75-260	255 - 264	185	120	125	
* TLKB-75-270	265 - 274	185	130	125	
* TLKB-75-280	275 - 284	185	140	125	
* TLKB-75-290	285 - 294	185	150	125	
* TLKB-75-320	295 - 324	185	180	125	
* TLKB-75-350	345 - 354	185	210	125	
* TLKB-75-380	355 - 384	185	240	125	
* TLKB-75-400	385 - 404	185	260	125	
* TLKB-75-420	405 - 424	185	280	125	
* TLKB-75-440	425 - 444	185	300	125	

* Levertijd op aanvraag

Rechtopstaande verwerking

Eurofast® EASYTOOL-PRO



Tule combinatie voor stalen ondergrond ≤ max 2 x 1.25 mm

EUROFAST® TRPSRB-45

BI-METAAL (RVS A4)



Torx 25 bitopname
Incl. EF-kopmarkering



Extra optie

Ook verkrijgbaar op band voor machinale verwerking

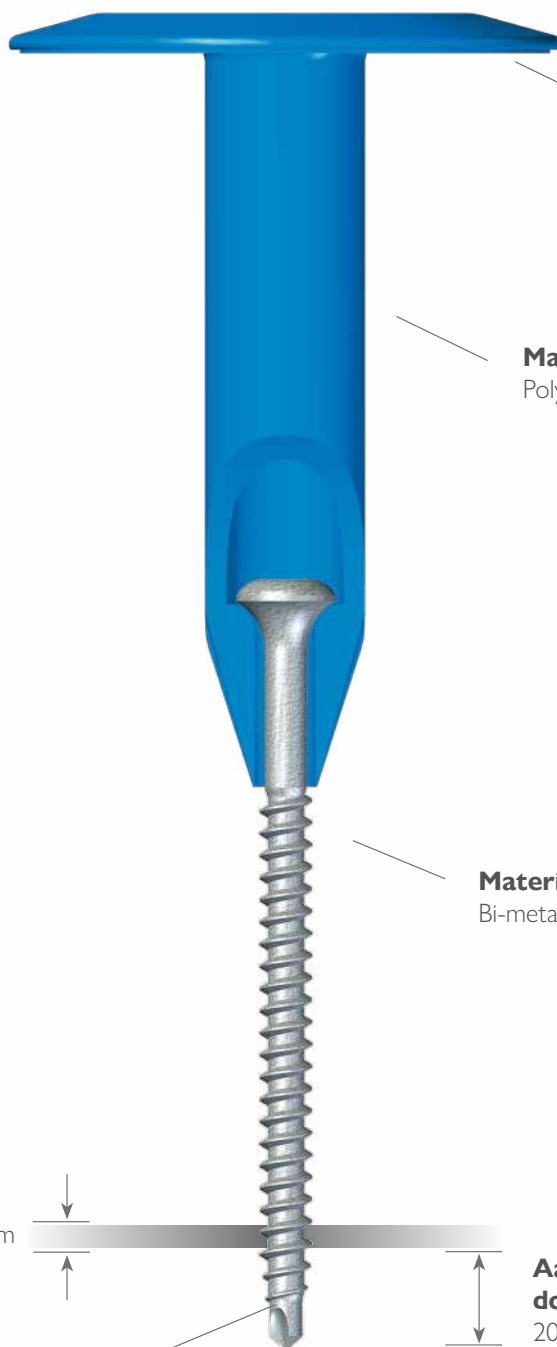

Diameter
Ø 45 mm

Materiaal
Polyamide PA6

Materiaal
Bi-metaal (RVS A4)

Staaldikte
≤ max 2 x 1.25 mm

Punt
Gereduceerde boorpunt

Aanbevolen doorsteek lengte
20 mm door de stalen dakplaat

Tule combinatie voor stalen ondergrond ≤ max 2 x 1.25 mm

Product key	Klembereik	Afmetingen			✉
	mm	Tule	Schroef		
* TRPSRB-45-050	45 - 54	30	60	250	
* TRPSRB-45-070	55 - 74	30	80	250	
* TRPSRB-45-080	75 - 84	60	60	250	
* TRPSRB-45-090	85 - 94	30	100	250	
* TRPSRB-45-100	95 - 104	60	80	250	
* TRPSRB-45-110	105 - 114	90	60	250	
* TRPSRB-45-120	115 - 124	60	100	250	
* TRPSRB-45-130	125 - 134	90	80	250	
* TRPSRB-45-140	135 - 144	120	60	250	
* TRPSRB-45-150	145 - 154	90	100	250	
* TRPSRB-45-160	155 - 164	120	80	250	
* TRPSRB-45-170	165 - 174	150	60	250	
* TRPSRB-45-180	175 - 184	120	100	250	

* Levertijd op aanvraag

Product key	Klembereik	Afmetingen			✉
	mm	Tule	Schroef		
* TRPSRB-45-190	185 - 194	150	80	250	
* TRPSRB-45-200	195 - 204	120	120	250	
* TRPSRB-45-210	205 - 214	150	100	250	
* TRPSRB-45-220	215 - 224	120	140	250	
* TRPSRB-45-230	225 - 234	150	120	250	
* TRPSRB-45-240	235 - 244	120	160	250	
* TRPSRB-45-250	245 - 254	150	140	250	
* TRPSRB-45-260	255 - 264	120	180	250	
* TRPSRB-45-270	265 - 274	150	160	250	
* TRPSRB-45-290	275 - 294	150	180	250	
* TRPSRB-45-320	295 - 324	150	210	250	
* TRPSRB-45-350	325 - 354	150	240	250	

Machinale verwerking

Eurofast® EURO-FIX



Rechtopstaande verwerking

Eurofast® EASYTOOL-PRO



Machinale verwerking					
Product key	Klembereik	Afmetingen			✉
	mm	Tule	Schroef		
* TRPSRBG-45-050	45 - 54	30	80	1000	
* TRPSRBG-45-070	55 - 74	30	100	1000	
* TRPSRBG-45-080	75 - 84	60	80	1000	
* TRPSRBG-45-090	85 - 94	90	60	1000	
* TRPSRBG-45-100	95 - 104	60	100	1000	
* TRPSRBG-45-110	105 - 114	90	80	1000	
* TRPSRBG-45-120	115 - 124	120	60	1000	
* TRPSRBG-45-130	125 - 134	90	100	1000	
* TRPSRBG-45-140	135 - 144	120	60	1000	
* TRPSRBG-45-150	145 - 154	90	100	1000	
* TRPSRBG-45-160	155 - 164	120	80	1000	

* Levertijd op aanvraag

Machinale verwerking					
Product key	Klembereik	Afmetingen			✉
	mm	Tule	Schroef		
* TRPSRBG-45-170	165 - 174	150	60	750	
* TRPSRBG-45-180	175 - 184	120	100	750	
* TRPSRBG-45-190	185 - 194	150	80	750	
* TRPSRBG-45-200	195 - 204	120	120	750	
* TRPSRBG-45-210	205 - 214	150	100	750	
* TRPSRBG-45-220	215 - 224	120	140	750	
* TRPSRBG-45-230	225 - 234	150	120	750	
* TRPSRBG-45-240	235 - 244	120	160	600	
* TRPSRBG-45-250	245 - 254	150	140	600	
* TRPSRBG-45-260	255 - 264	120	180	600	

Tule combinatie voor stalen ondergrond ≤ max 2 x 1.25 mm

EUROFAST® BTRPSRB-45

BI-METAAL (RVS A4)



Torx 25 bitopname
Incl. EF-kopmarkering

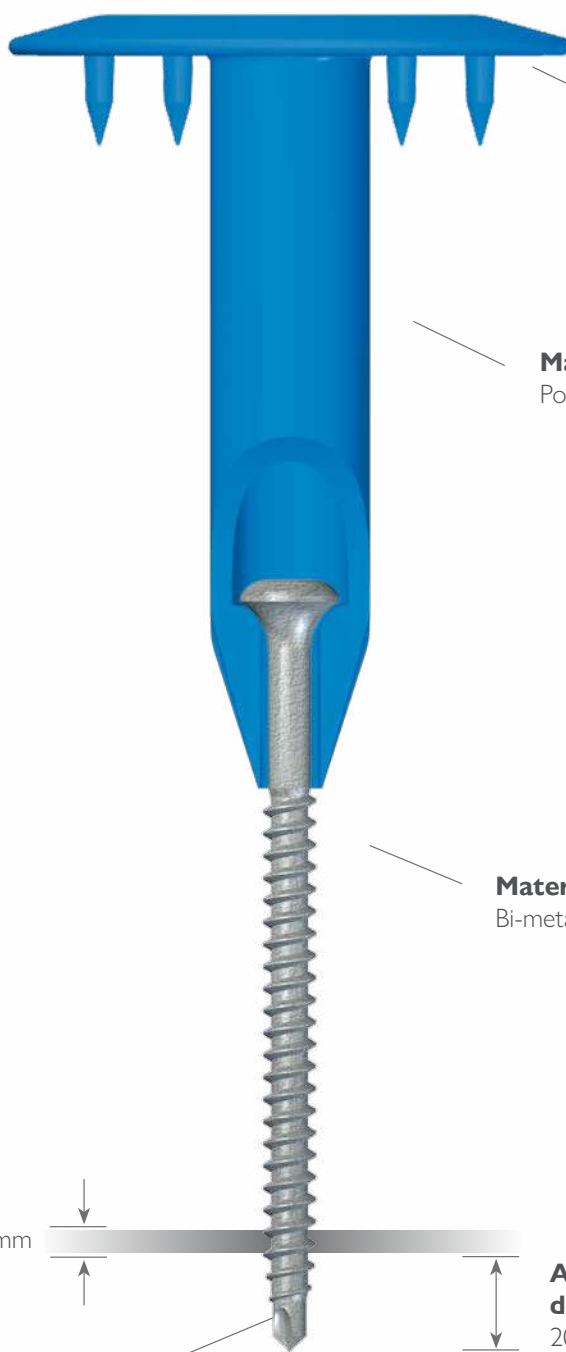

Diameter
Ø 45 mm

Materiaal
Polyamide PA6

Materiaal
Bi-metaal (RVS A4)

Staaldikte
≤ max 2 x 1.25 mm

Punt
Gereduceerde boorpunt

**Aanbevolen
doorsteek lengte**
20 mm door de
stalen dakplaat

Tule combinatie voor stalen ondergrond ≤ max 2 x 1.25 mm

Product key	Klembereik	Afmetingen		
	mm	Tule	Schroef	☒
* BTRPSRB-45-050	45 - 54	30	60	250
* BTRPSRB-45-070	55 - 74	30	80	250
* BTRPSRB-45-080	75 - 84	60	60	250
* BTRPSRB-45-090	85 - 94	30	100	250
* BTRPSRB-45-100	95 - 104	60	80	250
* BTRPSRB-45-110	105 - 114	90	60	250
* BTRPSRB-45-120	115 - 124	60	100	250
* BTRPSRB-45-130	125 - 134	90	80	250
* BTRPSRB-45-140	135 - 144	120	60	250
* BTRPSRB-45-150	145 - 154	90	100	250
* BTRPSRB-45-160	155 - 164	120	80	250
* BTRPSRB-45-170	165 - 174	150	60	250
* BTRPSRB-45-180	175 - 184	120	100	250

Product key	Klembereik	Afmetingen		
	mm	Tule	Schroef	☒
* BTRPSRB-45-190	185 - 194	150	80	250
* BTRPSRB-45-200	195 - 204	120	120	250
* BTRPSRB-45-210	205 - 214	150	100	250
* BTRPSRB-45-220	215 - 224	120	140	250
* BTRPSRB-45-230	225 - 234	150	120	250
* BTRPSRB-45-240	235 - 244	120	160	250
* BTRPSRB-45-250	245 - 254	150	140	250
* BTRPSRB-45-260	255 - 264	120	180	250
* BTRPSRB-45-270	265 - 274	150	160	250
* BTRPSRB-45-290	275 - 294	150	180	250
* BTRPSRB-45-320	295 - 324	150	210	250
* BTRPSRB-45-350	325 - 354	150	240	250

* Levertijd op aanvraag

Rechtopstaande verwerking

Eurofast® EASYTOOL-PRO



Tule combinatie voor stalen ondergrond ≤ max 2 x 1.25 mm

EUROFAST® TLKSRB-45

BI-METAAL (RVS A4)



Torx 25 bitopname
Incl. EF-kopmarkering

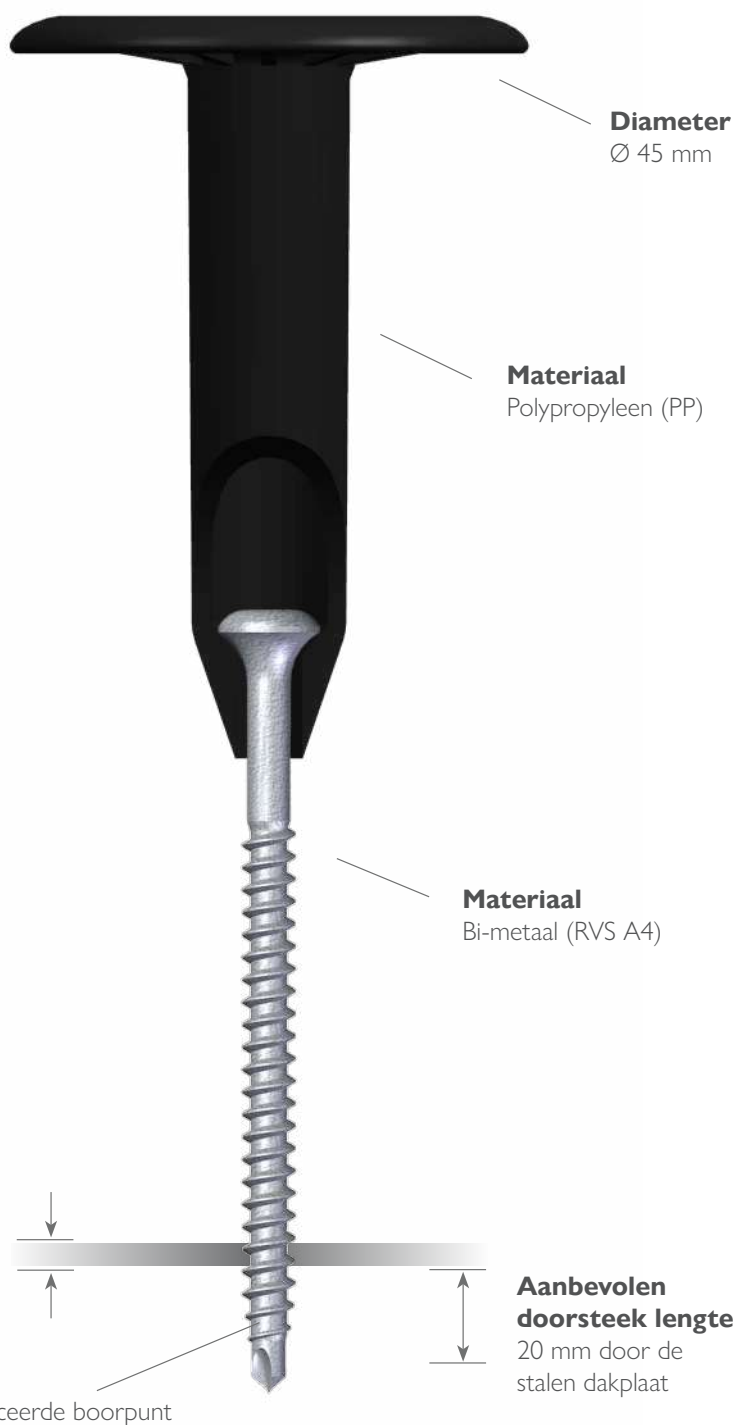

Tule combinatie voor stalen ondergrond ≤ max 2 x 1.25 mm

Product key	Klembereik	Afmetingen			☒
	mm	Tule	Schroef		
* TLKSRB-45-050	45 - 54	35	60	250	
* TLKSRB-45-070	55 - 74	35	80	250	
* TLKSRB-45-080	75 - 84	65	60	250	
* TLKSRB-45-090	85 - 94	35	100	250	
* TLKSRB-45-100	95 - 104	65	80	250	
* TLKSRB-45-110	105 - 114	35	120	250	
* TLKSRB-45-120	115 - 124	85	80	250	
* TLKSRB-45-130	125 - 134	35	140	250	
* TLKSRB-45-140	135 - 144	105	80	250	
* TLKSRB-45-150	145 - 154	135	60	250	
* TLKSRB-45-160	155 - 164	105	100	250	
* TLKSRB-45-170	165 - 174	135	80	250	
* TLKSRB-45-180	175 - 184	165	60	250	
* TLKSRB-45-190	185 - 194	135	100	250	
* TLKSRB-45-200	195 - 204	185	60	250	
* TLKSRB-45-210	205 - 214	135	120	250	
* TLKSRB-45-220	215 - 224	185	80	250	
* TLKSRB-45-230	225 - 234	135	140	250	
* TLKSRB-45-240	235 - 244	225	60	250	
* TLKSRB-45-250	245 - 254	135	160	250	

Product key	Klembereik	Afmetingen			☒
	mm	Tule	Schroef		
* TLKSRB-45-260	255 - 264	225	80	125	
* TLKSRB-45-270	265 - 274	255	60	125	
* TLKSRB-45-280	275 - 284	225	100	125	
* TLKSRB-45-290	285 - 294	255	80	125	
* TLKSRB-45-300	295 - 304	285	60	125	
* TLKSRB-45-310	305 - 314	255	100	125	
* TLKSRB-45-320	315 - 324	285	80	125	
* TLKSRB-45-330	325 - 334	255	120	125	
* TLKSRB-45-340	335 - 344	285	100	125	
* TLKSRB-45-350	345 - 354	185	210	125	
* TLKSRB-45-360	355 - 364	285	120	125	
* TLKSRB-45-370	365 - 374	255	160	125	
* TLKSRB-45-380	375 - 384	285	140	125	
* TLKSRB-45-390	385 - 394	255	180	125	
* TLKSRB-45-400	395 - 404	285	160	125	
* TLKSRB-45-420	405 - 424	320	140	125	
* TLKSRB-45-440	425 - 444	320	160	125	
* TLKSRB-45-460	445 - 464	320	180	125	
* TLKSRB-45-490	465 - 494	320	210	125	
* TLKSRB-45-520	495 - 524	320	240	125	

* Levertijd op aanvraag

Rechtopstaande verwerking

Eurofast® EASYTOOL-PRO



Tule combinatie voor stalen ondergrond ≤ max 2 x 1.25 mm

EUROFAST® TLKSRB-75

BI-METAAL (RVS A4)



Torx 25 bitopname
Incl. EF-kopmarkering

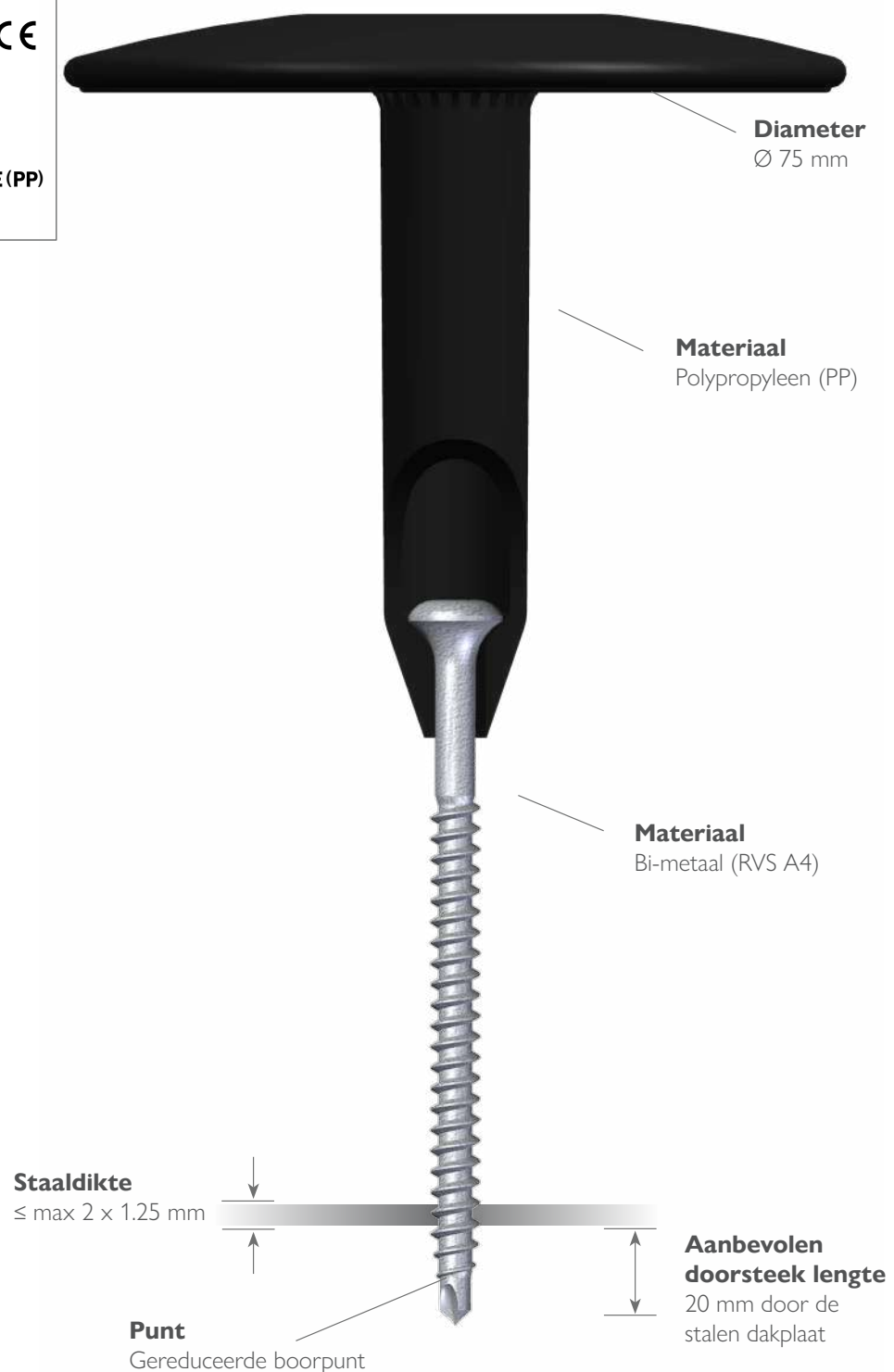

Tule combinatie voor stalen ondergrond ≤ max 2 x 1.25 mm

Product key	Klembereik	Afmetingen			☒
	mm	Tule	Schroef		
* TLKSRB-75-050	45 - 54	35	60	250	
* TLKSRB-75-070	55 - 74	35	80	250	
* TLKSRB-75-080	75 - 84	65	60	250	
* TLKSRB-75-090	85 - 94	35	100	250	
* TLKSRB-75-100	95 - 104	65	80	250	
* TLKSRB-75-110	105 - 114	35	120	250	
* TLKSRB-75-120	115 - 124	85	80	250	
* TLKSRB-75-130	125 - 134	35	140	250	
* TLKSRB-75-140	135 - 144	105	80	250	
* TLKSRB-75-150	145 - 154	135	60	250	
* TLKSRB-75-160	155 - 164	105	100	250	
* TLKSRB-75-170	165 - 174	135	80	250	
* TLKSRB-75-180	175 - 184	165	60	125	
* TLKSRB-75-190	185 - 194	135	100	125	
* TLKSRB-75-200	195 - 204	185	60	125	

Product key	Klembereik	Afmetingen			☒
	mm	Tule	Schroef		
* TLKSRB-75-210	205 - 214	135	120	125	
* TLKSRB-75-220	215 - 224	185	80	125	
* TLKSRB-75-230	225 - 234	135	140	125	
* TLKSRB-75-240	235 - 244	185	100	125	
* TLKSRB-75-250	245 - 254	135	160	125	
* TLKSRB-75-260	255 - 264	185	120	125	
* TLKSRB-75-270	265 - 274	135	180	125	
* TLKSRB-75-280	275 - 284	185	140	125	
* TLKSRB-75-300	285 - 304	185	160	125	
* TLKSRB-75-320	305 - 324	185	180	125	
* TLKSRB-75-330	325 - 334	165	210	125	
* TLKSRB-75-350	335 - 354	185	210	125	
* TLKSRB-75-360	355 - 364	165	240	125	
* TLKSRB-75-380	365 - 384	185	240	125	

* Levertijd op aanvraag

Rechtopstaande verwerking

Eurofast® EASYTOOL-PRO



Dakbevestigers voor houten ondergrond

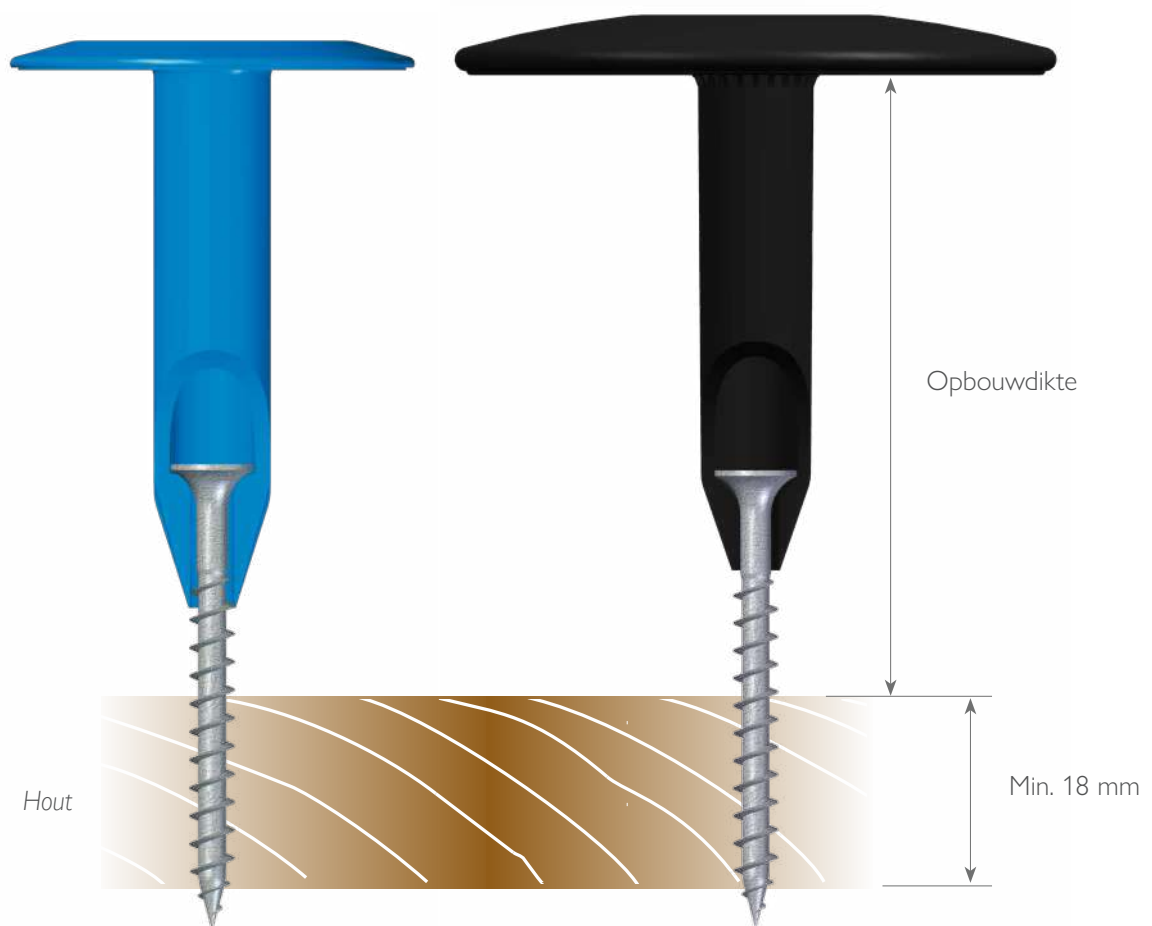
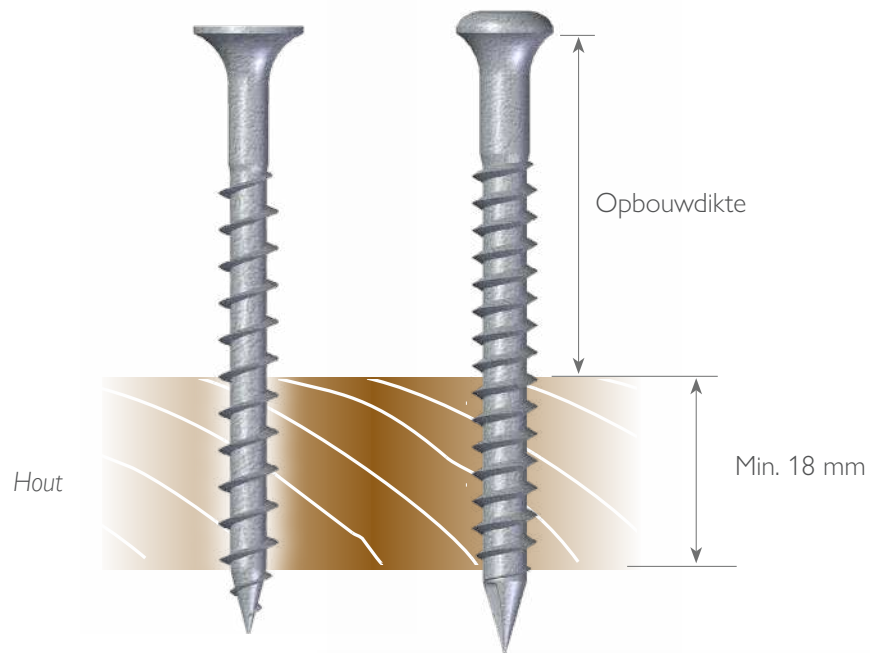

Dakbevestigigers voor houten ondergrond

15-cycli Kesternich

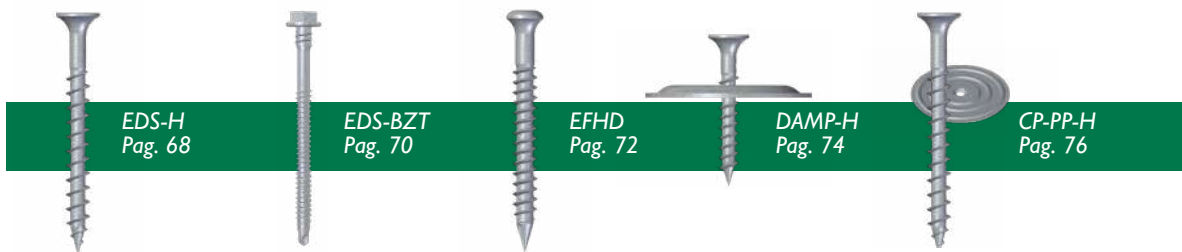

15-cycli Kesternich - Tule combinatie

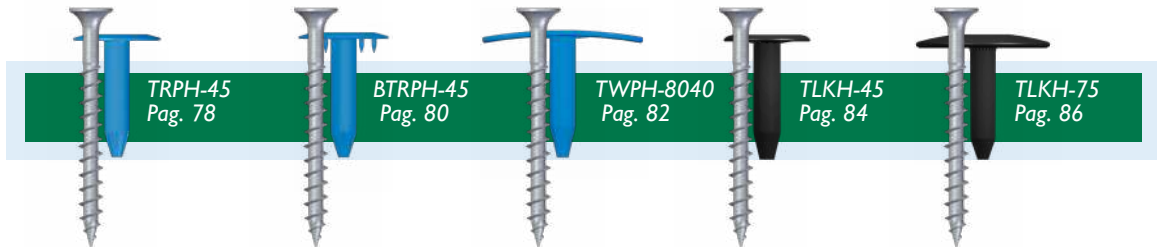

Houten ondergrond

EUROFAST® EDS-H

15-CYCLI KESTERNICH

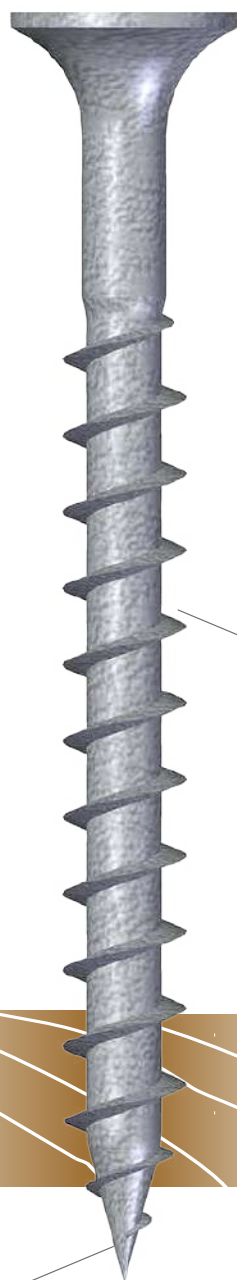

PH2 bitopname
Incl. EF-kopmarkering

**Materiaal**

Staal verzinkt met
Magni-Silver coating

**Aanbevolen lengte
volle draad in het
hout**

Min. 18 mm

Punt

Geharde S-punt

Houten ondergrond

Product key	Afmetingen			☒
	Ø	Schroef	Draad	
EDS-H-50020	5.0	20	15	1000
EDS-H-50025	5.0	25	20	1000
EDS-H-50030	5.0	30	25	1000
EDS-H-50035	5.0	35	30	1000
EDS-H-50040	5.0	40	35	1000
EDS-H-50045	5.0	45	40	1000
EDS-H-50055	5.0	55	50	1000
EDS-H-50065	5.0	65	50	500
EDS-H-50075	5.0	75	50	500
EDS-H-50095	5.0	95	50	500
EDS-H-50120	5.0	120	50	500

Houten ondergrond

EUROFAST® EDS-BZT

15-CYCLI KESTERNICH



Extra optie

Ook verkrijgbaar op band voor machinale verwerking



HWH 8 mm kop
Incl. EF-kopmarkering



Stapzeker

Materiaal

Staal verzinkt met
Magni-Silver coating

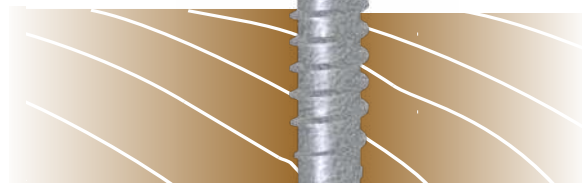

**Aanbevolen lengte
volle draad in het
hout**

Min. 18 mm

Punt

Gereduceerde boorpunt

Houten ondergrond

Product key	Afmetingen			
	Ø	Schroef	Draad	☒
EDS-BZT48060	4.8	60	50	500
EDS-BZT48070	4.8	70	50	500
EDS-BZT48080	4.8	80	50	500
EDS-BZT48090	4.8	90	50	500
EDS-BZT48100	4.8	100	50	500
EDS-BZT48120	4.8	120	75	500
EDS-BZT48140	4.8	140	75	500
EDS-BZT48160	4.8	160	105	500
EDS-BZT48180	4.8	180	120	500
EDS-BZT48200	4.8	200	120	500
EDS-BZT48220	4.8	220	120	500
EDS-BZT48240	4.8	240	120	500
EDS-BZT48260	4.8	260	120	500
EDS-BZT48280	4.8	280	120	500
EDS-BZT48300	4.8	300	120	500

Machinale verwerking

Eurofast® DEK-FIX



Machinale verwerking

EDS-BGT48060	4.8	60	50	1200
EDS-BGT48070	4.8	70	50	1200
EDS-BGT48080	4.8	80	50	1200
EDS-BGT48090	4.8	90	50	1200
EDS-BGT48100	4.8	100	50	1050
EDS-BGT48120	4.8	120	75	1050
EDS-BGT48140	4.8	140	75	750
EDS-BGT48160	4.8	160	105	750
EDS-BGT48180	4.8	180	120	750
EDS-BGT48200	4.8	200	120	750
EDS-BGT48220	4.8	220	120	750
EDS-BGT48240	4.8	240	120	750

Houten ondergrond

EUROFAST® EFHD

15-CYCLI KESTERNICH



Torx 25 bitopname
Incl. EF-kopmarkering

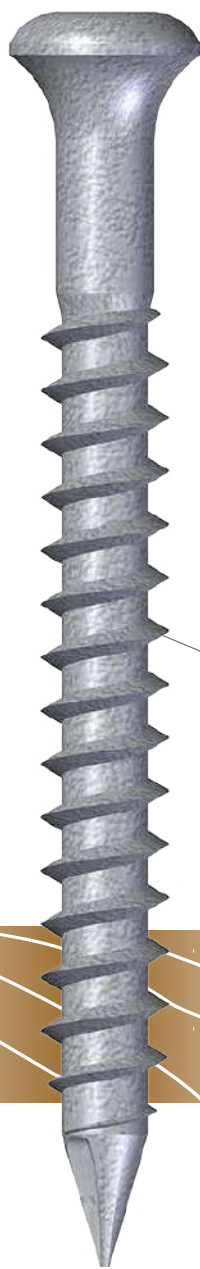

Materiaal
Staal verzinkt met
Magni-Silver coating

**Aanbevolen lengte
volle draad in het
hout**
Min. 18 mm

Punt
Ricoh punt

Houten ondergrond

Product key	Afmetingen			
	Ø	Schroef	Draad	⊠
EFHD-63030	6.3	30	25	1000
EFHD-63045	6.3	45	40	1000
EFHD-63060	6.3	60	55	500
EFHD-63070	6.3	70	60	500
EFHD-63080	6.3	80	60	500
EFHD-63100	6.3	100	70	500
EFHD-63130	6.3	130	70	500
EFHD-63160	6.3	160	70	500
EFHD-63180	6.3	180	70	500
EFHD-63200	6.3	200	70	500
EFHD-63230	6.3	230	70	500
EFHD-63250	6.3	250	70	500
EFHD-63275	6.3	275	70	500
EFHD-63300	6.3	300	70	500
EFHD-63330	6.3	330	70	500
EFHD-63350	6.3	350	70	500
EFHD-63400	6.3	400	70	250

Houten ondergrond

EUROFAST® DAMP-H

15-CYCLI KESTERNICH



PH2 bitopname
Incl. EF-kopmarkering

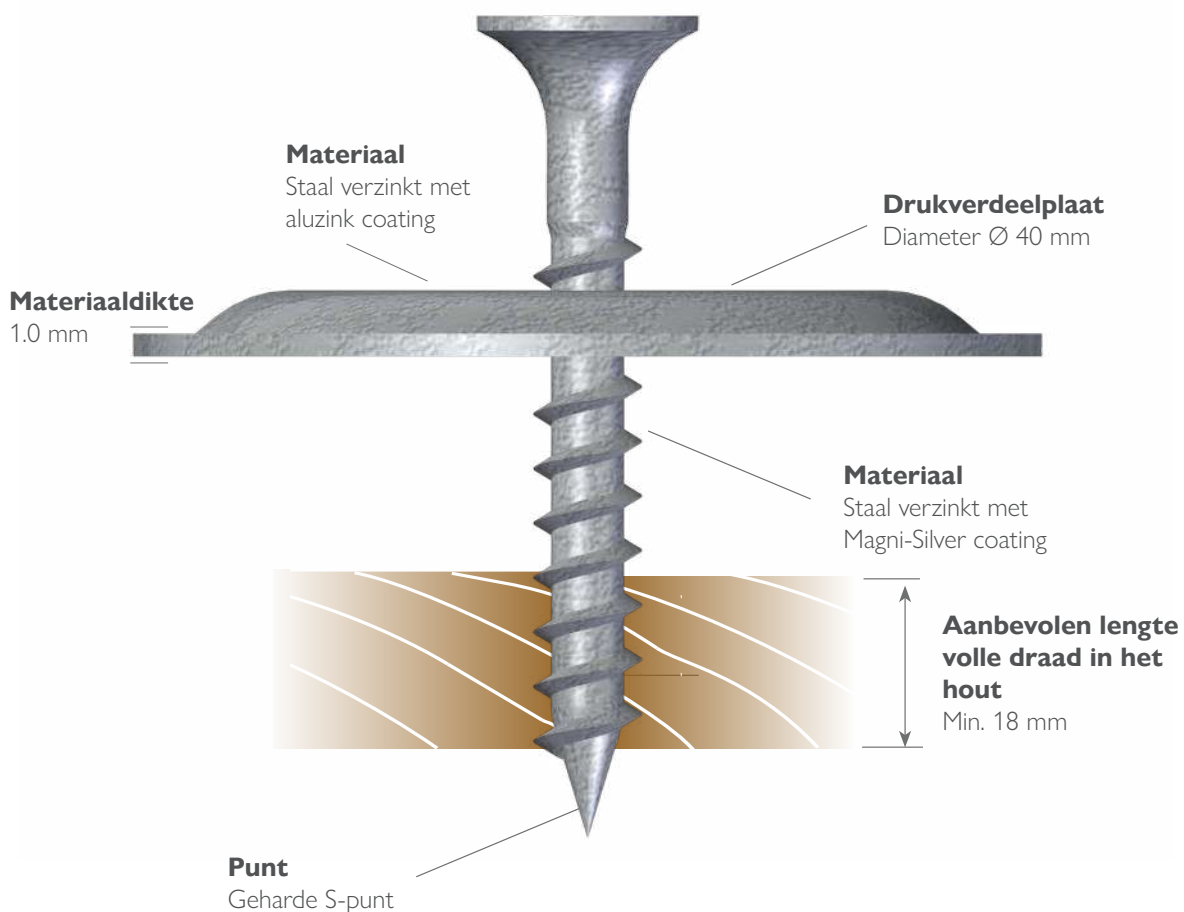

Houten ondergrond

Product key	Afmetingen			
	Ø	Schroef	Draad	⊠
DAMP-50020H	5.0	20	15	250
DAMP-50025H	5.0	25	20	250
DAMP-50030H	5.0	30	25	250
DAMP-50035H	5.0	35	30	250
DAMP-50040H	5.0	40	35	250
DAMP-50045H	5.0	45	40	250
DAMP-50055H	5.0	55	50	250
DAMP-50065H	5.0	65	50	250
DAMP-50075H	5.0	75	50	250
DAMP-50095H	5.0	95	50	250
DAMP-50120H	5.0	120	50	250

Rechtopstaande verwerking

Eurofast® EASYTOOL-DAMP



Schroefbit

PH2 M6

Diameter Ø 8 mm

240260525065

Houten ondergrond

EUROFAST® CP-PP-H

15-CYCLI KESTERNICH

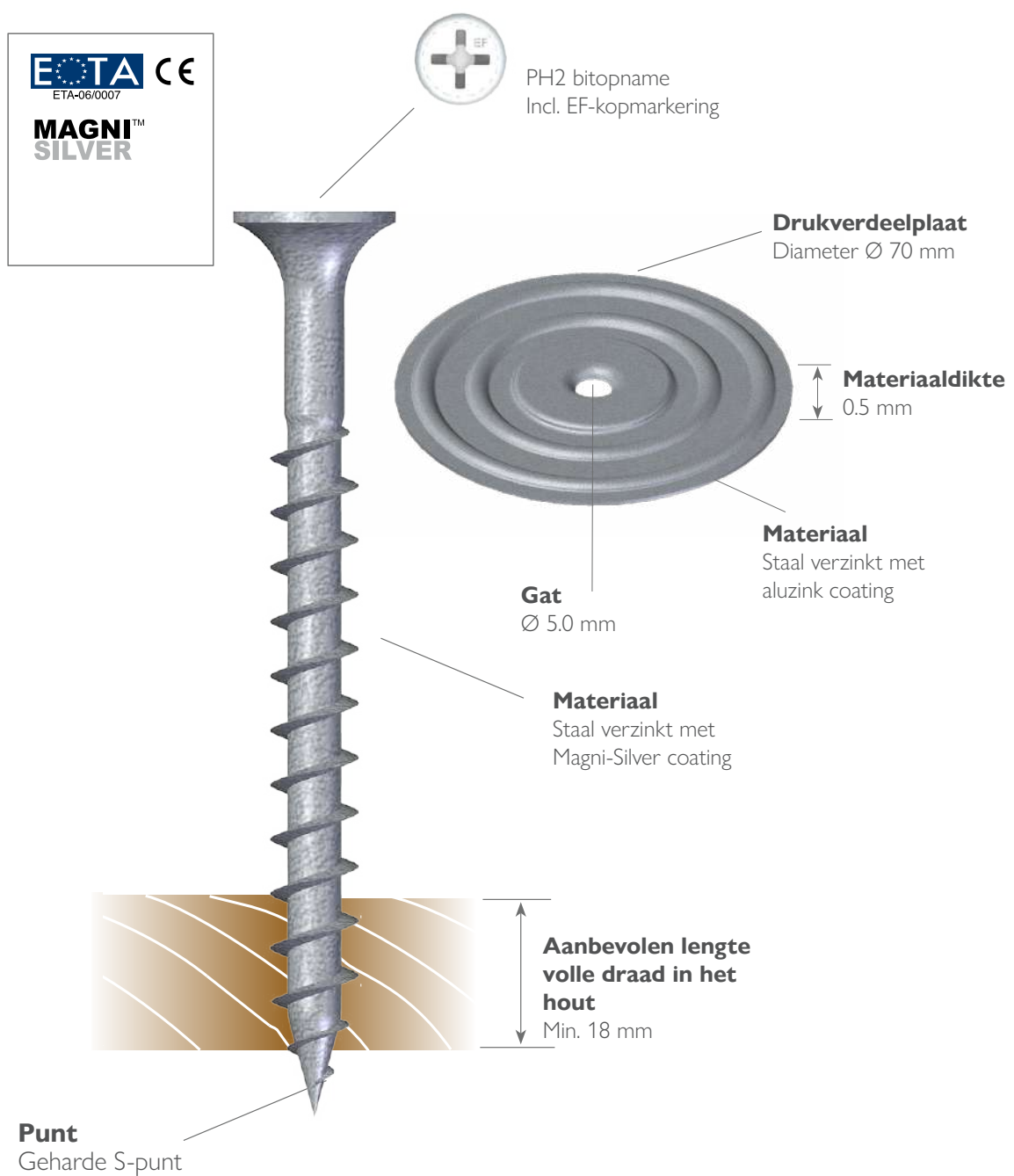

Houten ondergrond

Product key	Afmetingen			
	Ø	Schroef	Draad	⊠
CP-PP-50020H	5.0	20	15	250
CP-PP-50025H	5.0	25	20	250
CP-PP-50035H	5.0	35	30	250
CP-PP-50045H	5.0	45	40	250
CP-PP-50055H	5.0	55	50	250
CP-PP-50075H	5.0	75	50	250
CP-PP-50095H	5.0	95	50	250
CP-PP-50120H	5.0	120	50	250

Tule combinatie voor houten ondergrond

EUROFAST® TRPH-45

15-CYCLI KESTERNICH



PH2 bitopname
Incl. EF-kopmarkering

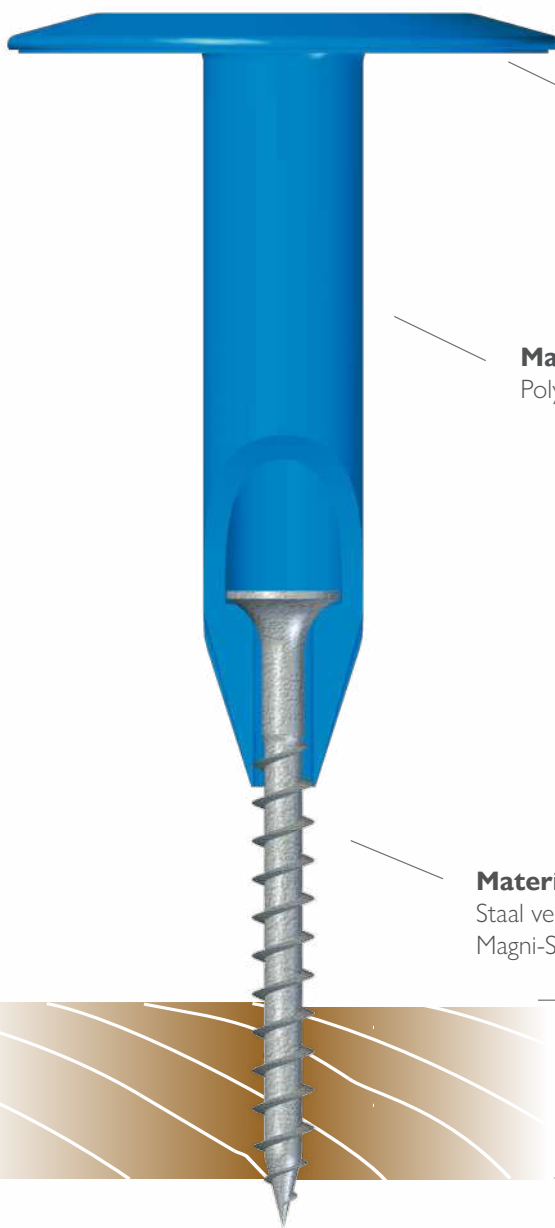

Diameter
Ø 45 mm

Materiaal
Polyamide PA6

Materiaal
Staal verzinkt met
Magni-Silver coating

**Aanbevolen
lengte volle
draad in
het hout**
Min. 18 mm

Punt
Geharde S-punt

Extra optie

Ook verkrijgbaar op band
voor machinale verwerking



Tule combinatie voor houten ondergrond

Product key	Klembereik	Afmetingen			✉
	mm	Tule	Schroef		
* TRPH-45-050	45 - 54	30	65	250	
* TRPH-45-060	55 - 64	30	75	250	
* TRPH-45-080	65 - 84	60	65	250	
* TRPH-45-090	85 - 94	60	75	250	
* TRPH-45-110	95 - 114	90	65	250	
* TRPH-45-120	115 - 124	90	75	250	
* TRPH-45-140	125 - 144	120	65	250	
* TRPH-45-150	145 - 154	120	75	250	
* TRPH-45-170	155 - 174	150	65	250	

* Levertijd op aanvraag

Product key	Klembereik	Afmetingen			✉
	mm	Tule	Schroef		
* TRPH-45-180	175 - 184	150	75	250	
* TRPH-45-195	185 - 210	150	95	250	
* TRPH-45-225	211 - 235	150	120	250	
* TRPH-45-250	236 - 265	225	75	250	
* TRPH-45-275	266 - 285	225	95	250	
* TRPH-45-300	286 - 310	225	120	250	
* TRPH-45-315	311 - 325	285	75	250	
* TRPH-45-335	326 - 345	285	95	250	
* TRPH-45-360	346 - 375	285	120	250	

Machinale verwerking

Eurofast® EURO-FIX



Rechtopstaande verwerking

Eurofast® EASYTOOL-PRO



Machinale verwerking					
Product key	Klembereik	Afmetingen			✉
	mm	Tule	Schroef		
* TRPHG-45-050	45 - 54	30	65	1000	
* TRPHG-45-060	55 - 64	30	75	1000	
* TRPHG-45-080	65 - 84	60	65	1000	
* TRPHG-45-090	85 - 94	60	75	1000	
* TRPHG-45-110	95 - 114	90	65	1000	
* TRPHG-45-120	115 - 124	90	75	1000	

* Levertijd op aanvraag

Machinale verwerking					
Product key	Klembereik	Afmetingen			✉
	mm	Tule	Schroef		
* TRPHG-45-140	125 - 144	120	65	1000	
* TRPHG-45-150	145 - 154	120	75	1000	
* TRPHG-45-170	155 - 174	150	65	750	
* TRPHG-45-180	175 - 184	150	75	750	
* TRPHG-45-195	185 - 210	150	95	750	
* TRPHG-45-225	211 - 235	150	120	750	

Tule combinatie voor houten ondergrond

EUROFAST® BTRPH-45

15-CYCLI KESTERNICH



PH2 bitopname
Incl. EF-kopmarkering

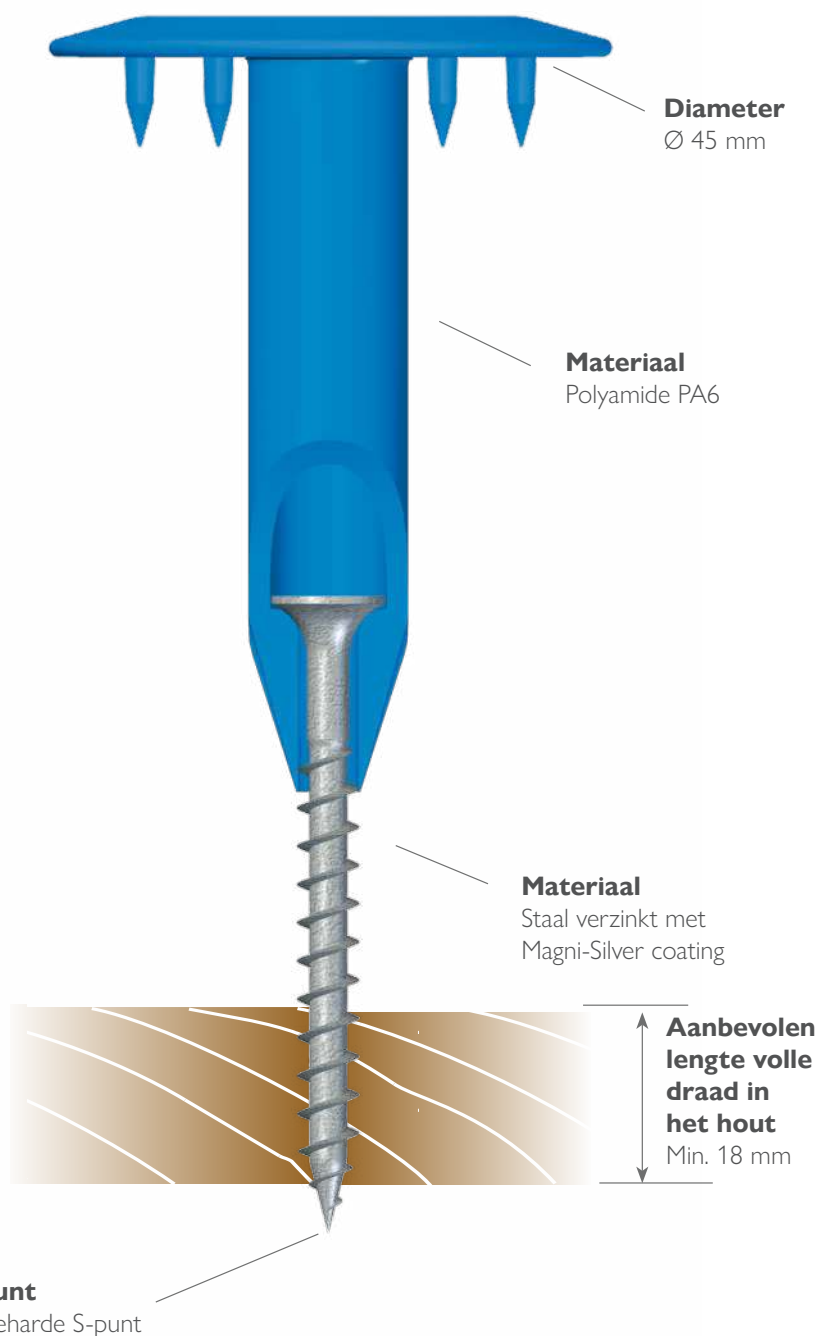

Tule combinatie voor houten ondergrond

Product key	Klembereik	Afmetingen		
	mm	Tule	Schroef	⊠
* BTRPH-45-050	45 - 54	30	65	250
* BTRPH-45-060	55 - 64	30	75	250
* BTRPH-45-080	65 - 84	60	65	250
* BTRPH-45-090	85 - 94	60	75	250
* BTRPH-45-110	95 - 114	90	65	250
* BTRPH-45-120	115 - 124	90	75	250

Product key	Klembereik	Afmetingen		
	mm	Tule	Schroef	⊠
* BTRPH-45-140	125 - 144	120	65	250
* BTRPH-45-150	145 - 154	120	75	250
* BTRPH-45-170	155 - 174	150	65	250
* BTRPH-45-180	175 - 184	150	75	250
* BTRPH-45-195	185 - 210	150	95	250
* BTRPH-45-225	211 - 235	150	120	250

* Levertijd op aanvraag

Rechtopstaande verwerking

Eurofast® EASYTOOL-PRO



Tule combinatie voor houten ondergrond

EUROFAST® TWPH-8040

15-CYCLI KESTERNICH



PH2 bitopname
Incl. EF-kopmarkering

Extra optie

Ook verkrijgbaar op band voor machinale verwerking

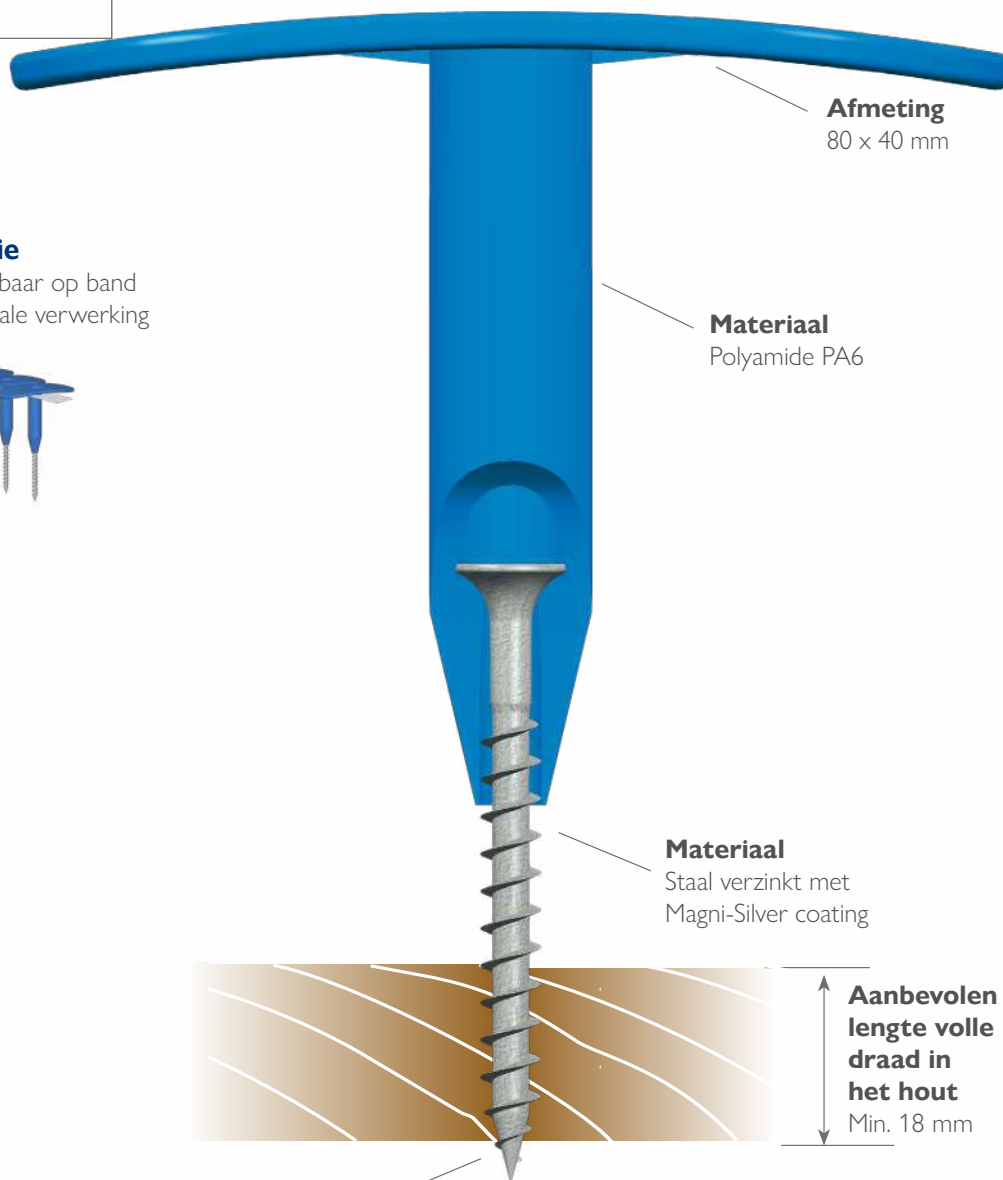

Afmeting
80 x 40 mm

Materiaal
Polyamide PA6

Materiaal
Staal verzinkt met
Magni-Silver coating

**Aanbevolen
lengte volle
draad in
het hout**
Min. 18 mm

Punt
Geharde S-punt

Tule combinatie voor houten ondergrond

Product key	Klembereik	Afmetingen			☒
	mm	Tule	Schroef		
* TWPH-8040-050	45 - 54	30	65	250	
* TWPH-8040-060	55 - 64	30	75	250	
* TWPH-8040-080	65 - 84	60	65	250	
* TWPH-8040-090	85 - 94	60	75	250	
* TWPH-8040-110	95 - 114	90	65	250	
* TWPH-8040-120	115 - 124	90	75	250	

* Levertijd op aanvraag

Product key	Klembereik	Afmetingen			☒
	mm	Tule	Schroef		
* TWPH-8040-140	125 - 144	120	65	250	
* TWPH-8040-150	145 - 154	120	75	250	
* TWPH-8040-170	155 - 174	150	65	250	
* TWPH-8040-180	175 - 184	150	75	250	
* TWPH-8040-195	185 - 200	120	120	250	
* TWPH-8040-225	201 - 229	150	120	250	

Machinale verwerking

Eurofast® EURO-FIX



Rechtopstaande verwerking

Eurofast® EASYTOOL-PRO



Machinale verwerking					
Product key	Klembereik	Afmetingen			☒
	mm	Tule	Schroef		
* TWPHG-8040-050	45 - 54	30	65	1000	
* TWPHG-8040-060	55 - 64	30	75	1000	
* TWPHG-8040-080	75 - 84	60	65	1000	
* TWPHG-8040-090	85 - 94	60	75	1000	
* TWPHG-8040-110	105 - 114	90	65	1000	
* TWPHG-8040-120	115 - 124	90	75	750	

* Levertijd op aanvraag

Machinale verwerking					
Product key	Klembereik	Afmetingen			☒
	mm	Tule	Schroef		
* TWPHG-8040-140	125 - 144	120	65	500	
* TWPHG-8040-150	145 - 154	120	75	500	
* TWPHG-8040-170	155 - 174	150	65	500	
* TWPHG-8040-180	175 - 184	150	75	500	
* TWPHG-8040-195	185 - 200	120	120	500	
* TWPHG-8040-225	201 - 229	150	120	500	

Tule combinatie voor houten ondergrond

EUROFAST® TLKH-45

15-CYCLI KESTERNICH



PH2 bitopname
Incl. EF-kopmarkering

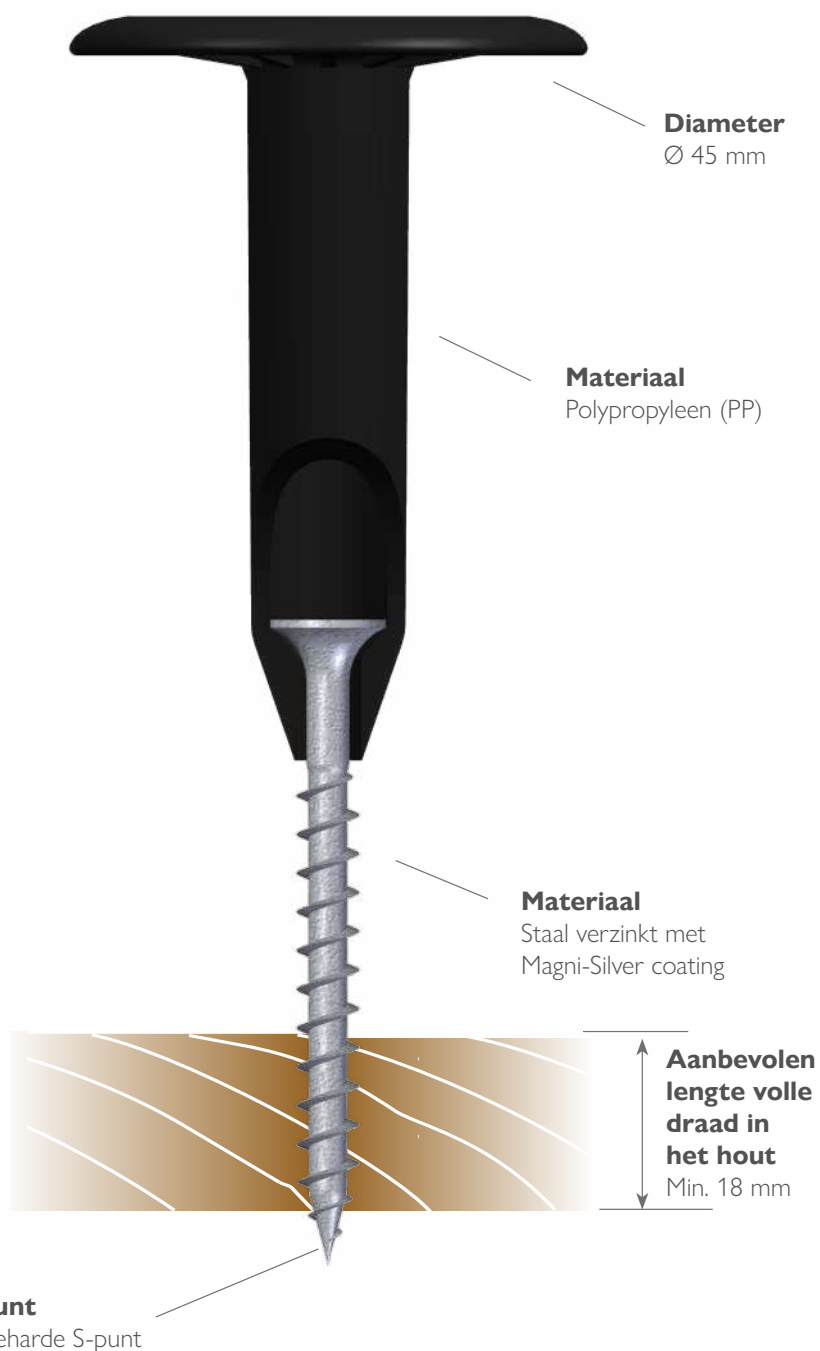

Tule combinatie voor houten ondergrond

Product key	Klembereik	Afmetingen			☒
	mm	Tule	Schroef		
* TLKH-45-050	45 - 54	35	65	250	
* TLKH-45-060	55 - 64	35	75	250	
* TLKH-45-080	65 - 84	65	65	250	
* TLKH-45-090	85 - 94	65	75	250	
* TLKH-45-110	95 - 114	85	75	250	
* TLKH-45-130	115 - 134	105	75	250	
* TLKH-45-150	135 - 154	105	95	250	
* TLKH-45-160	155 - 164	135	75	250	
* TLKH-45-180	165 - 184	135	95	250	

Product key	Klembereik	Afmetingen			☒
	mm	Tule	Schroef		
* TLKH-45-210	185 - 214	135	120	250	
* TLKH-45-230	215 - 234	185	95	250	
* TLKH-45-260	235 - 264	185	120	250	
* TLKH-45-270	265 - 274	225	95	125	
* TLKH-45-300	275 - 304	255	95	125	
* TLKH-45-330	305 - 334	255	120	125	
* TLKH-45-360	335 - 364	285	120	125	
* TLKH-45-390	365 - 394	320	120	125	

* Levertijd op aanvraag

Rechtopstaande verwerking

Eurofast® EASYTOOL-PRO



Tule combinatie voor houten ondergrond

EUROFAST® TLKH-75

15-CYCLI KESTERNICH



PH2 bitopname
Incl. EF-kopmarkering

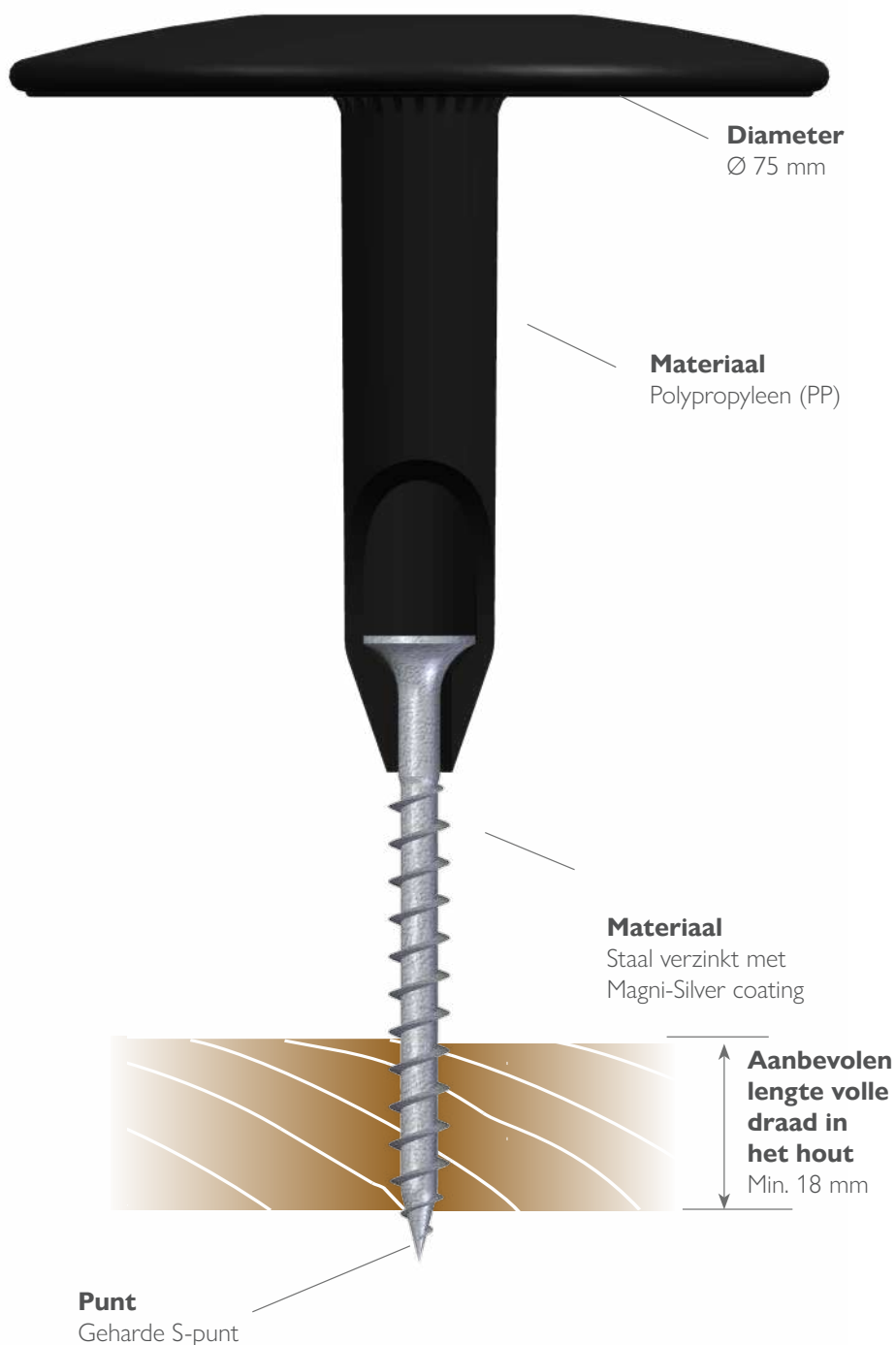

Tule combinatie voor houten ondergrond

Product key	Klembereik	Afmetingen		
	mm	Tule	Schroef	⊠
* TLKH-75-050	45 - 54	35	65	250
* TLKH-75-060	55 - 64	35	75	250
* TLKH-75-080	65 - 84	65	65	250
* TLKH-75-090	85 - 94	65	75	250
* TLKH-75-110	95 - 114	85	75	250
* TLKH-75-130	115 - 134	105	75	250

Product key	Klembereik	Afmetingen		
	mm	Tule	Schroef	⊠
* TLKH-75-150	135 - 154	105	95	250
* TLKH-75-160	155 - 164	135	75	250
* TLKH-75-180	165 - 184	135	95	125
* TLKH-75-210	185 - 214	185	75	125
* TLKH-75-230	215 - 234	185	95	125
* TLKH-75-260	235 - 264	185	120	125

* Levertijd op aanvraag

Rechtopstaande verwerking

Eurofast® EASYTOOL-PRO



Dakbevestigers voor gasbetonnen ondergrond

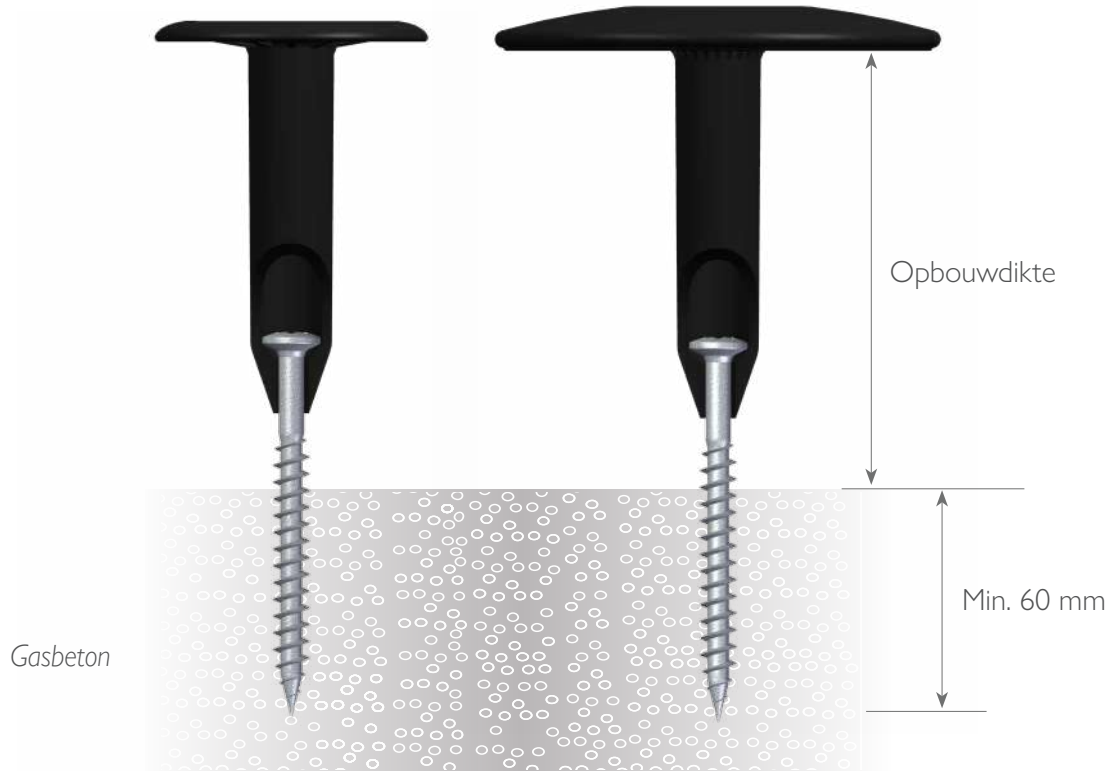
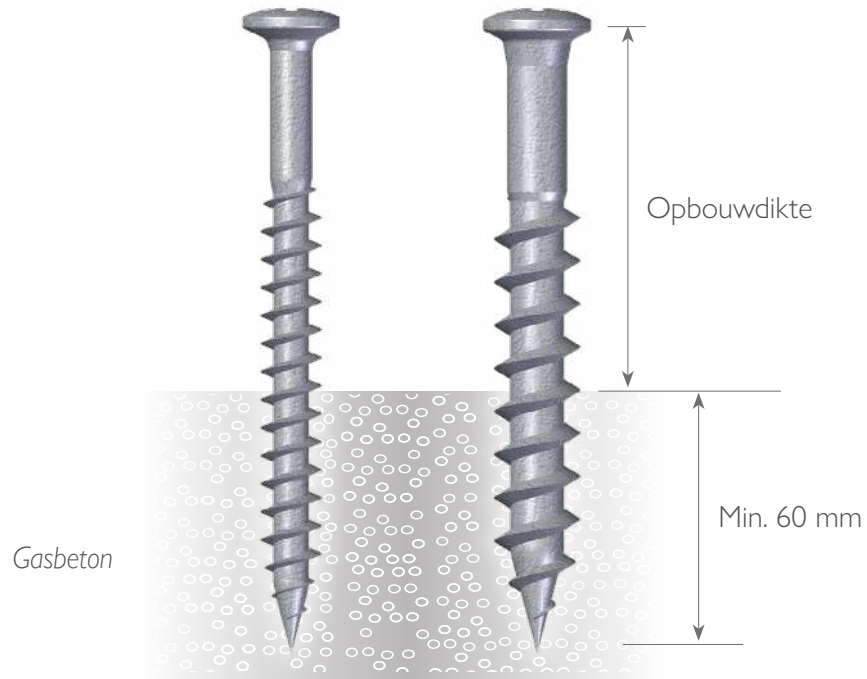

Dakbevestigers voor gasbetonnen ondergrond

15-cycli Kesternich



RVS A2



15-cycli Kesternich - Tule combinatie



RVS A2 - Tule combinatie



Gasbetonnen ondergrond

EUROFAST® GBS-60

15-CYCLI KESTERNICH



Torx 25 bitopname
Incl. EF-kopmarkering

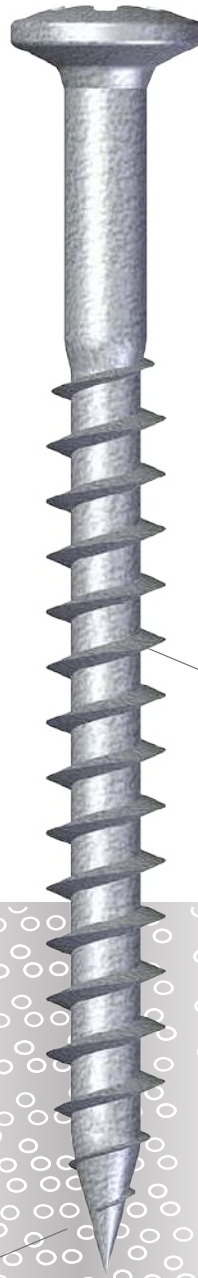

Materiaal
Staal verzinkt met
Magni-Silver coating

**Aanbevolen lengte
in het gasbeton**
Min. 60 mm

Punt
Geharde S-punt

Gasbetonnen ondergrond

Product key	Afmetingen			
	Ø	Schroef	Draad	⊠
GBS-60060	6.0	60	50	500
GBS-60070	6.0	70	60	500
GBS-60080	6.0	80	70	500
GBS-60090	6.0	90	80	500
GBS-60100	6.0	100	80	500
GBS-60110	6.0	110	80	500
GBS-60120	6.0	120	80	500
GBS-60130	6.0	130	80	500
GBS-60140	6.0	140	80	500
GBS-60160	6.0	160	80	500
GBS-60180	6.0	180	80	500
GBS-60200	6.0	200	80	500

Toerental

De verwerking van de Eurofast® GBS-60 is het meest optimaal met een laag toerental.

Advies: max. 1000 rpm

Gasbetonnen ondergrond

EUROFAST® GBS-80

15-CYCLI KESTERNICH



Torx 25 bitopname
Incl. EF-kopmarkering

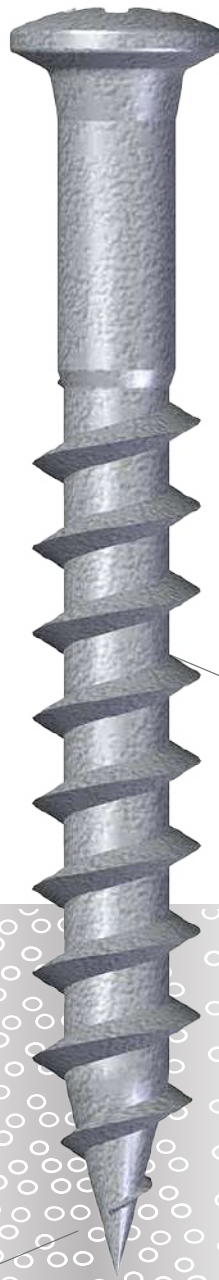

Materiaal
Staal verzinkt met
Magni-Silver coating

**Aanbevolen lengte
in het gasbeton**
Min. 60 mm

Punt
Geharde S-punt

Gasbetonnen ondergrond

Product key	Afmetingen			
	Ø	Schroef	Draad	⊠
GBS-80065	8.0	65	65	500
GBS-80090	8.0	90	70	500
GBS-80110	8.0	110	70	500
GBS-80130	8.0	130	70	500
GBS-80160	8.0	160	70	500
GBS-80190	8.0	190	70	500
GBS-80240	8.0	240	70	250

Toerental

De verwerking van de Eurofast® GBS-80 is het meest optimaal met een laag toerental.

Advies: max. 1000 rpm

Gasbetonnen ondergrond

EUROFAST® GBSA2

RVS A2



Torx 25 bitopname
Incl. EF-kopmarkering

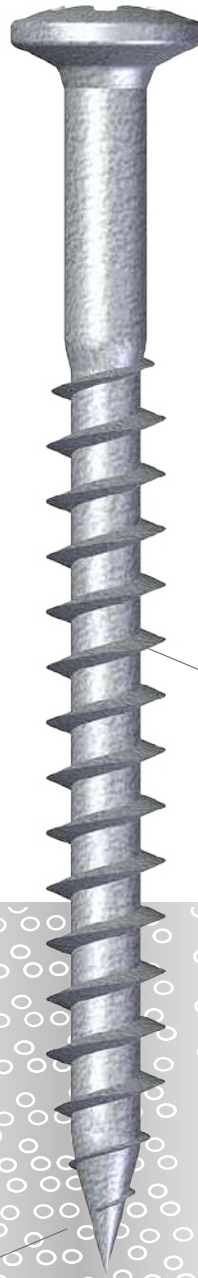

Materiaal
RVS A2 met
gepassiveerde coating

**Aanbevolen lengte
in het gasbeton**
Min. 60 mm

Punt
Geharde S-punt

Gasbetonnen ondergrond

Product key	Afmetingen			
	Ø	Schroef	Draad	⊠
GBSA2-60100	6.0	100	70	500
GBSA2-60120	6.0	120	80	500
GBSA2-60160	6.0	160	80	500
GBSA2-60200	6.0	200	80	500

Toerental

De verwerking van de Eurofast® GBSA2 is het meest optimaal met een laag toerental.

Advies: max. 1000 rpm

Tule combinatie voor gasbetonnen ondergrond

EUROFAST® TLKGBS-45

15-CYCLI KESTERNICH



Torx 25 bitopname
Incl. EF-kopmarkering

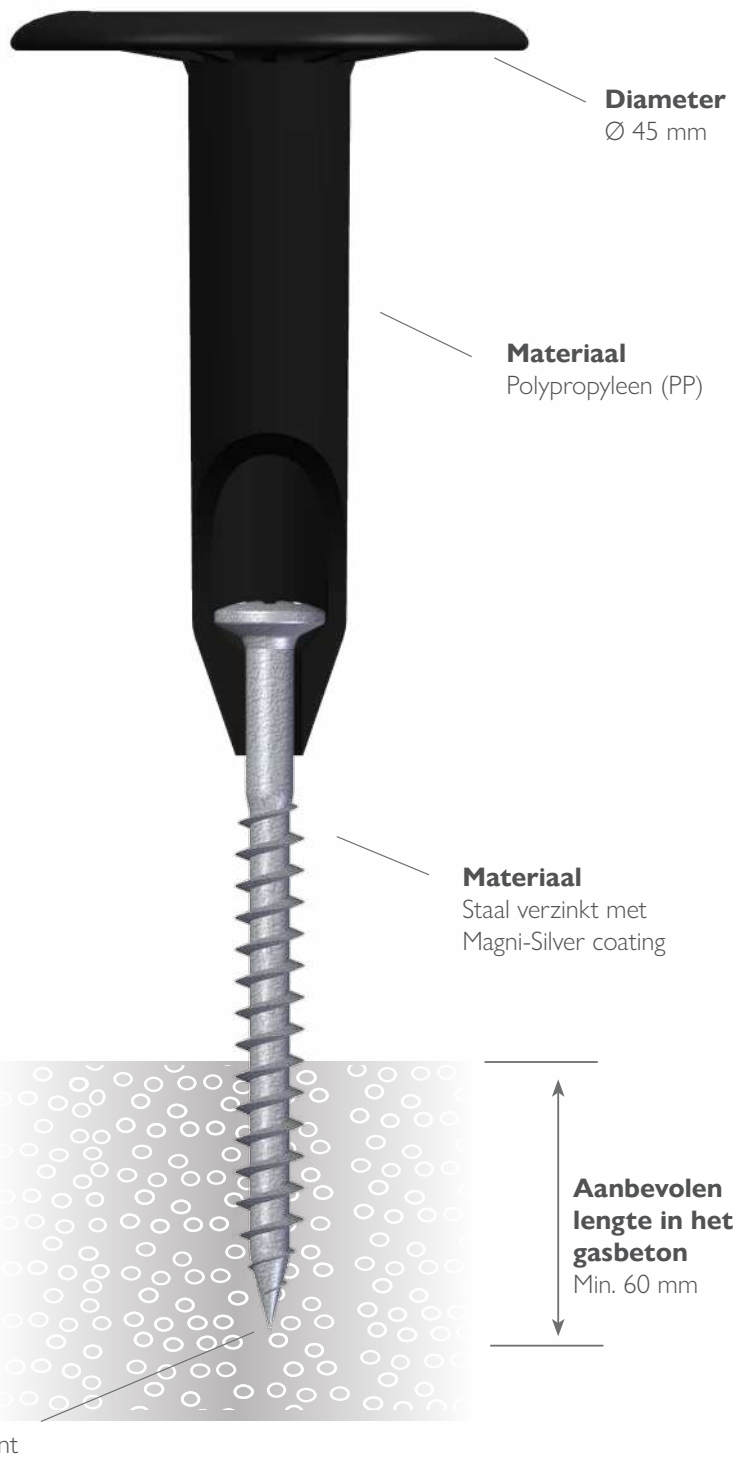

Tule combinatie voor gasbetonnen ondergrond

Product key	Klembereik	Afmetingen		
	mm	Tule	Schroef	⊠
* TLKGBS-45-060	55 - 64	35	100	250
* TLKGBS-45-070	65 - 74	35	110	250
* TLKGBS-45-080	75 - 84	35	120	250
* TLKGBS-45-090	85 - 94	65	100	250
* TLKGBS-45-100	95 - 104	65	110	250
* TLKGBS-45-110	105 - 114	65	120	250
* TLKGBS-45-120	115 - 124	65	130	250
* TLKGBS-45-130	125 - 134	65	140	250
* TLKGBS-45-140	135 - 144	85	130	250
* TLKGBS-45-150	145 - 154	105	120	250
* TLKGBS-45-170	155 - 174	105	140	250
* TLKGBS-45-180	175 - 184	135	120	250
* TLKGBS-45-190	185 - 194	105	160	250
* TLKGBS-45-200	195 - 204	135	140	250
* TLKGBS-45-210	205 - 214	185	100	250
* TLKGBS-45-220	215 - 224	135	160	250
* TLKGBS-45-230	225 - 234	185	120	250

Product key	Klembereik	Afmetingen		
	mm	Tule	Schroef	⊠
* TLKGBS-45-240	235 - 244	185	130	250
* TLKGBS-45-250	245 - 254	185	140	250
* TLKGBS-45-270	255 - 274	225	120	125
* TLKGBS-45-280	275 - 284	225	130	125
* TLKGBS-45-290	285 - 294	225	140	125
* TLKGBS-45-300	295 - 304	255	120	125
* TLKGBS-45-310	305 - 314	255	130	125
* TLKGBS-45-320	315 - 324	255	140	125
* TLKGBS-45-330	325 - 334	255	180	125
* TLKGBS-45-340	335 - 344	255	160	125
* TLKGBS-45-350	345 - 354	255	200	125
* TLKGBS-45-360	355 - 364	255	180	125
* TLKGBS-45-380	365 - 384	320	130	125
* TLKGBS-45-390	385 - 394	320	140	125
* TLKGBS-45-410	395 - 414	320	160	125
* TLKGBS-45-430	415 - 434	320	180	125
* TLKGBS-45-450	435 - 454	320	200	125

* Levertijd op aanvraag

Rechtopstaande verwerking

Eurofast® EASYTOOL-PRO



Toerental

De verwerking van de Eurofast® TLKGBS-45 is het meest optimaal met een laag toerental.

Advies: max. 1000 rpm

Tule combinatie voor gasbetonnen ondergrond

EUROFAST® TLKGBS-75

15-CYCLI KESTERNICH



Torx 25 bitopname
Incl. EF-kopmarkering

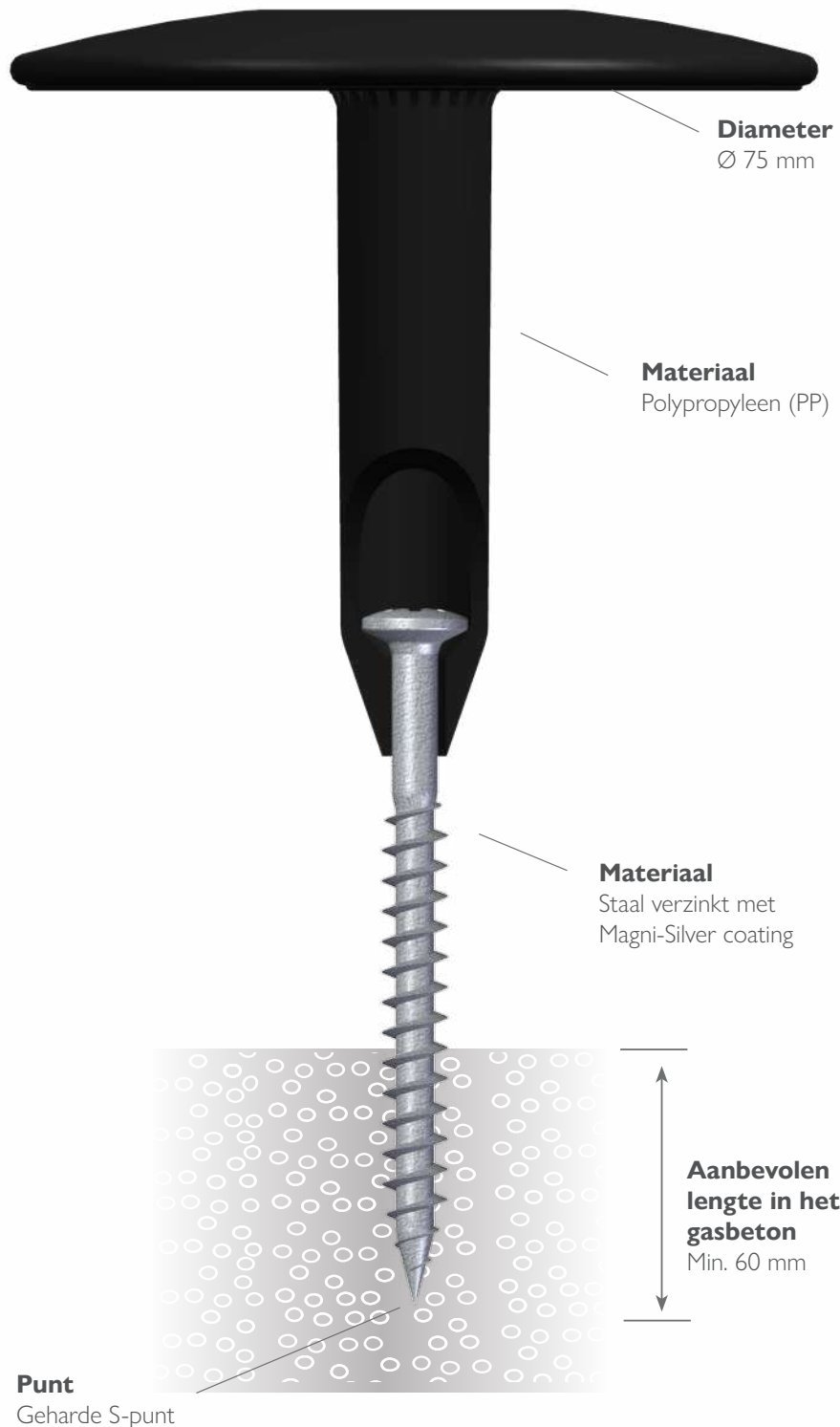

Tule combinatie voor gasbetonnen ondergrond

Product key	Klembereik	Afmetingen		
	mm	Tule	Schroef	⊠
* TLKGBS-75-060	55 - 64	35	100	250
* TLKGBS-75-070	65 - 74	35	110	250
* TLKGBS-75-080	75 - 84	35	120	250
* TLKGBS-75-090	85 - 94	65	100	250
* TLKGBS-75-100	95 - 104	65	110	250
* TLKGBS-75-110	105 - 114	65	120	250
* TLKGBS-75-120	115 - 124	65	130	250
* TLKGBS-75-130	125 - 134	65	140	250
* TLKGBS-75-140	135 - 144	85	130	250
* TLKGBS-75-150	145 - 154	105	120	250
* TLKGBS-75-170	155 - 174	105	140	250

Product key	Klembereik	Afmetingen		
	mm	Tule	Schroef	⊠
* TLKGBS-75-180	175 - 184	135	120	125
* TLKGBS-75-190	185 - 194	105	160	125
* TLKGBS-75-200	195 - 204	135	140	125
* TLKGBS-75-210	205 - 214	185	100	125
* TLKGBS-75-220	215 - 224	185	110	125
* TLKGBS-75-230	225 - 234	185	120	125
* TLKGBS-75-240	235 - 244	185	130	125
* TLKGBS-75-250	245 - 254	185	140	125
* TLKGBS-75-270	255 - 274	185	160	125
* TLKGBS-75-290	275 - 294	185	180	125
* TLKGBS-75-310	295 - 314	185	200	125

* Levertijd op aanvraag

Rechtopstaande verwerking

Eurofast® EASYTOOL-PRO



Toerental

De verwerking van de Eurofast® TLKGBS-75 is het meest optimaal met een laag toerental.

Advies: max. 1000 rpm

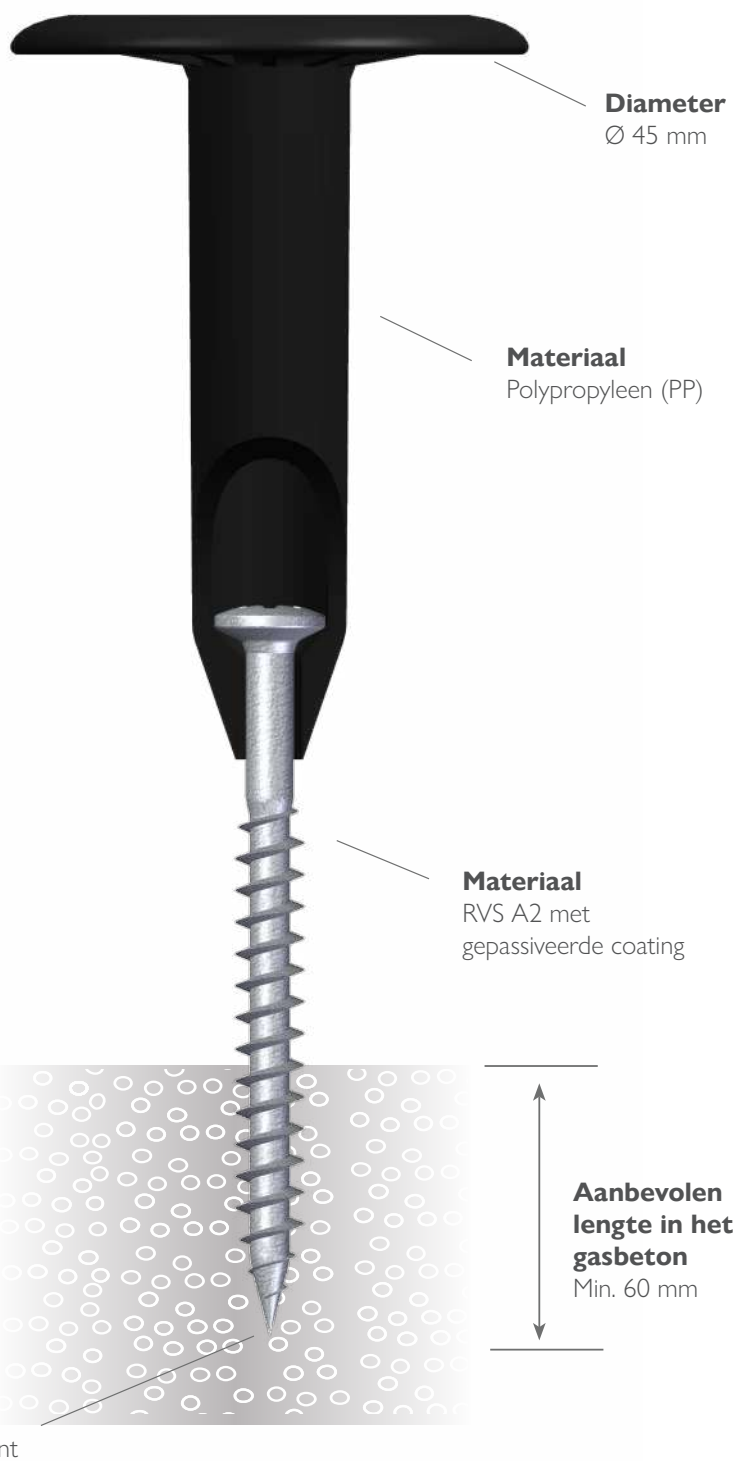
Tule combinatie voor gasbetonnen ondergrond**EUROFAST® TLKGBSA2-45****RVS A2**Torx 25 bitopname
Incl. EF-kopmarkering

Tule combinatie voor gasbetonnen ondergrond

Product key	Klembereik	Afmetingen		
	mm	Tule	Schroef	⊠
* TLKGBSA2-45-060	55 - 64	35	100	250
* TLKGBSA2-45-080	65 - 84	35	120	250
* TLKGBSA2-45-090	85 - 94	65	100	250
* TLKGBSA2-45-110	95 - 114	85	100	250
* TLKGBSA2-45-120	115 - 124	35	160	250
* TLKGBSA2-45-130	125 - 134	105	100	250
* TLKGBSA2-45-150	135 - 154	105	120	250
* TLKGBSA2-45-160	155 - 164	135	100	250
* TLKGBSA2-45-170	165 - 174	85	160	250
* TLKGBSA2-45-180	175 - 184	135	120	250
* TLKGBSA2-45-190	185 - 194	165	100	250
* TLKGBSA2-45-210	195 - 214	185	100	250
* TLKGBSA2-45-220	215 - 224	135	160	250

Product key	Klembereik	Afmetingen		
	mm	Tule	Schroef	⊠
* TLKGBSA2-45-230	225 - 234	185	120	250
* TLKGBSA2-45-250	235 - 254	225	100	125
* TLKGBSA2-45-260	255 - 264	135	200	125
* TLKGBSA2-45-270	265 - 274	225	120	125
* TLKGBSA2-45-280	275 - 284	255	100	125
* TLKGBSA2-45-290	285 - 294	165	200	125
* TLKGBSA2-45-300	295 - 304	255	120	125
* TLKGBSA2-45-310	305 - 314	225	160	125
* TLKGBSA2-45-350	315 - 354	320	100	125
* TLKGBSA2-45-370	355 - 374	320	120	125
* TLKGBSA2-45-380	375 - 384	255	200	125
* TLKGBSA2-45-410	385 - 414	320	160	125
* TLKGBSA2-45-450	415 - 454	320	200	125

* Levertijd op aanvraag

Rechttopstaande verwerking

Eurofast® EASYTOOL-PRO



Toerental

De verwerking van de Eurofast® TLKGBSA2-45 is het meest optimaal met een laag toerental.

Advies: max. 1000 rpm

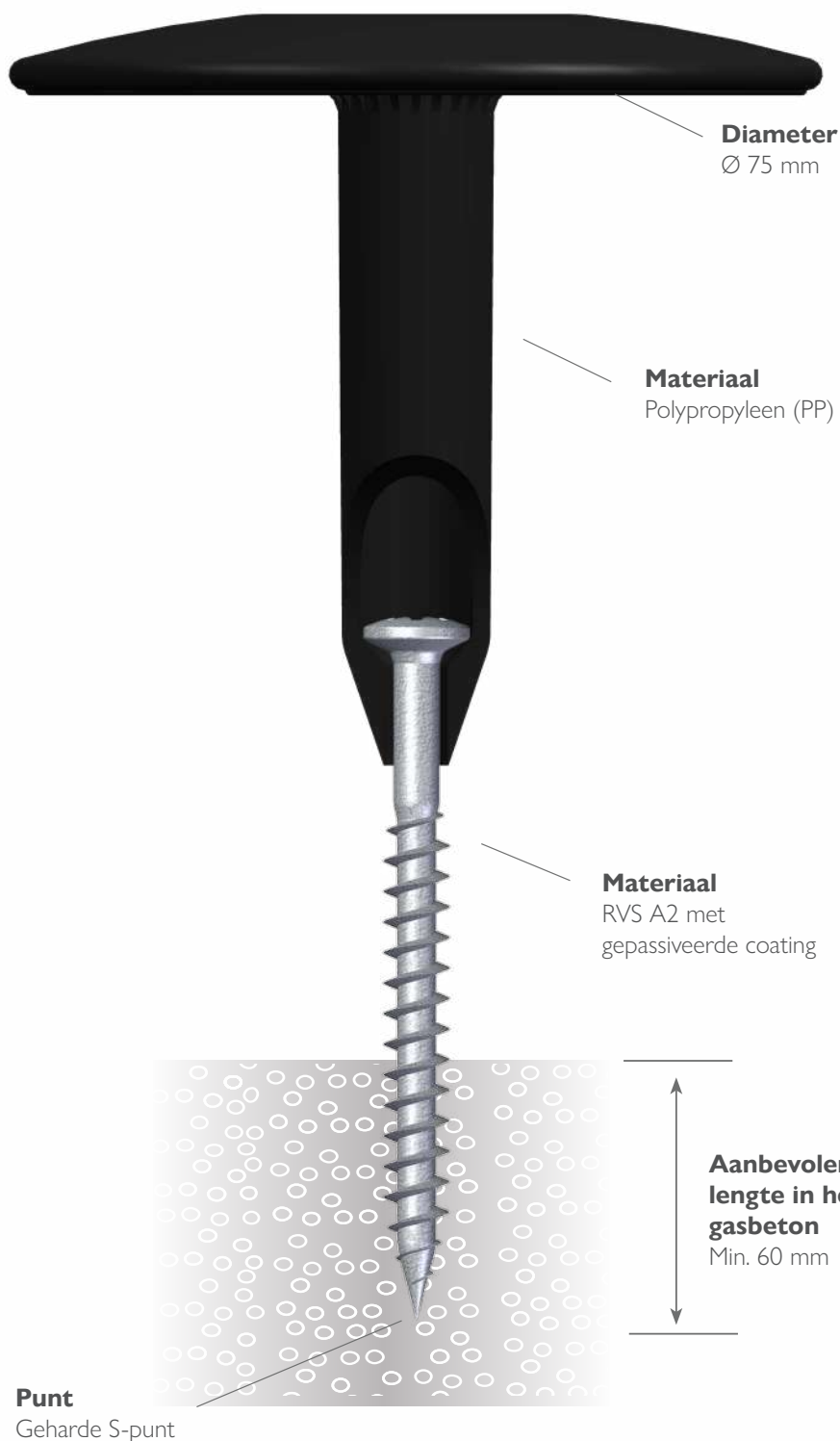
Tule combinatie voor gasbetonnen ondergrond**EUROFAST® TLKGBSA2-75****RVS A2**Torx 25 bitopname
Incl. EF-kopmarkering

Tule combinatie voor gasbetonnen ondergrond

Product key	Klembereik	Afmetingen		
	mm	Tule	Schroef	⊠
* TLKGBSA2-75-060	55 - 64	35	100	250
* TLKGBSA2-75-070	65 - 74	35	120	250
* TLKGBSA2-75-090	75 - 94	65	100	250
* TLKGBSA2-75-100	95 - 104	65	120	250
* TLKGBSA2-75-110	105 - 114	85	100	250
* TLKGBSA2-75-120	115 - 124	35	160	250
* TLKGBSA2-75-130	125 - 134	105	100	250
* TLKGBSA2-75-140	135 - 144	85	140	250
* TLKGBSA2-75-150	145 - 154	105	120	250
* TLKGBSA2-75-160	155 - 164	135	100	250
* TLKGBSA2-75-170	165 - 174	85	160	250

Product key	Klembereik	Afmetingen		
	mm	Tule	Schroef	⊠
* TLKGBSA2-75-180	175 - 184	135	120	125
* TLKGBSA2-75-190	185 - 194	165	100	125
* TLKGBSA2-75-200	195 - 204	135	140	125
* TLKGBSA2-75-210	205 - 214	185	100	125
* TLKGBSA2-75-220	215 - 224	135	160	125
* TLKGBSA2-75-230	225 - 234	185	120	125
* TLKGBSA2-75-240	235 - 244	185	140	125
* TLKGBSA2-75-250	245 - 254	165	160	125
* TLKGBSA2-75-270	255 - 274	185	160	125
* TLKGBSA2-75-290	275 - 294	165	200	125
* TLKGBSA2-75-310	295 - 314	185	200	125

* Levertijd op aanvraag

Rechtopstaande verwerking

Eurofast® EASYTOOL-PRO



Toerental

De verwerking van de Eurofast® TLKGBSA2-75 is het meest optimaal met een laag toerental.

Advies: max. 1000 rpm

Dakbevestigers voor betonnen ondergrond

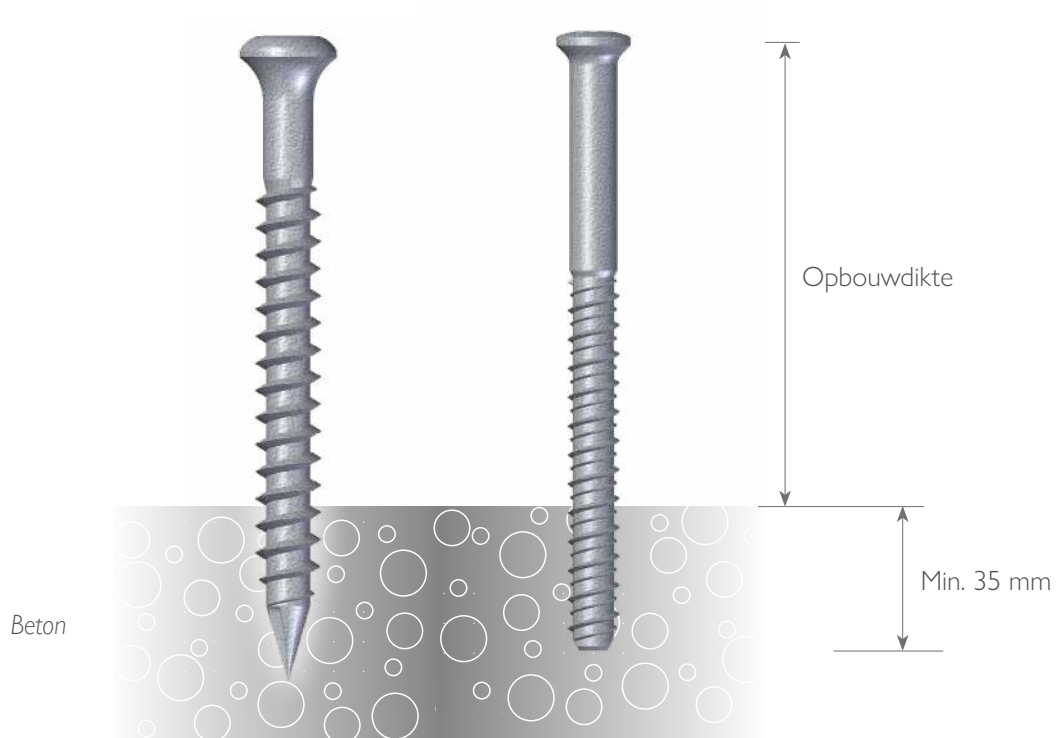

Dakbevestigers voor betonnen ondergrond

15-cycli Kesternich



30-cycli Kesternich



RVS A2



15-cycli Kesternich - Tule combinatie - Afschotbevestiging

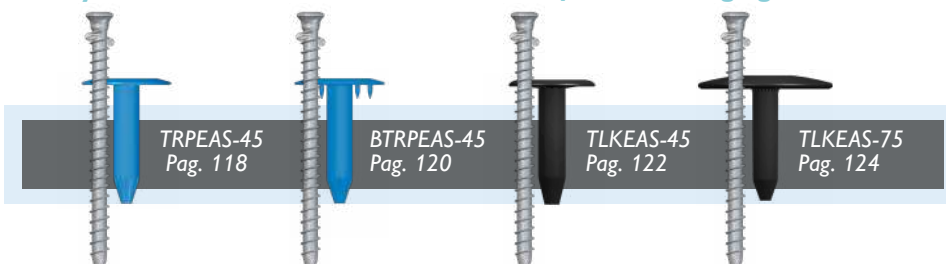

15-cycli Kesternich - Tule combinatie

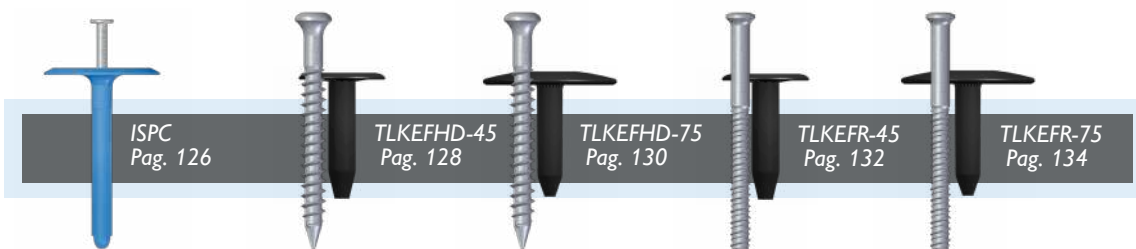

RVS A2 - Tule combinatie

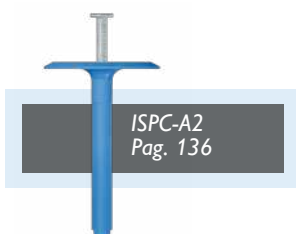

Betonnen ondergrond

EUROFAST® EFHD

15-CYCLI KESTERNICH



Torx 25 bitopname
Incl. EF-kopmarkering

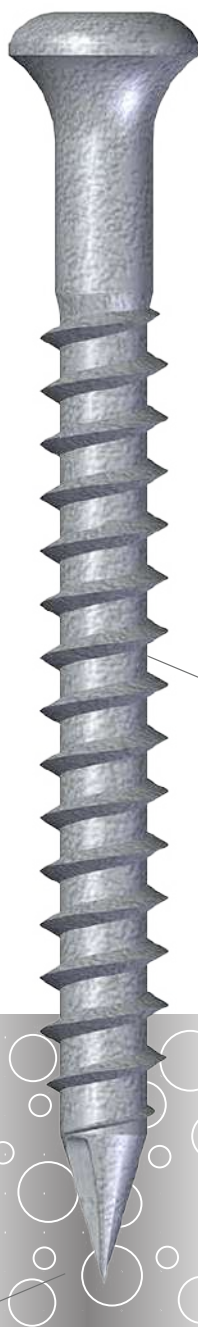

Materiaal
Staal verzinkt met
Magni-Silver coating

**Aanbevolen lengte
in het beton**
Min. 35 mm

Punt
Ricoh punt

Betonnen ondergrond

Product key	Afmetingen			
	Ø	Schroef	Draad	⊠
EFHD-63030	6.3	30	25	1000
EFHD-63045	6.3	45	40	1000
EFHD-63060	6.3	60	55	500
EFHD-63070	6.3	70	60	500
EFHD-63080	6.3	80	60	500
EFHD-63100	6.3	100	70	500
EFHD-63130	6.3	130	70	500
EFHD-63160	6.3	160	70	500
EFHD-63180	6.3	180	70	500
EFHD-63200	6.3	200	70	500
EFHD-63230	6.3	230	70	500
EFHD-63250	6.3	250	70	500
EFHD-63275	6.3	275	70	500
EFHD-63300	6.3	300	70	500
EFHD-63330	6.3	330	70	500
EFHD-63350	6.3	350	70	500
EFHD-63400	6.3	400	70	250

Vorboren

Boordiameter Ø 5.0, 5.2 of 5.5 mm gebruiken om voor te boren. De boordiameter is afhankelijk van de kwaliteit van het beton. Boordiepte: Minimaal 10 mm dieper boren dan de lengte van de bevestiger.

Betonnen ondergrond**EUROFAST® EFR****15-CYCLI KESTERNICH**

Torx 25 bitopname
Incl. EF-kopmarkering

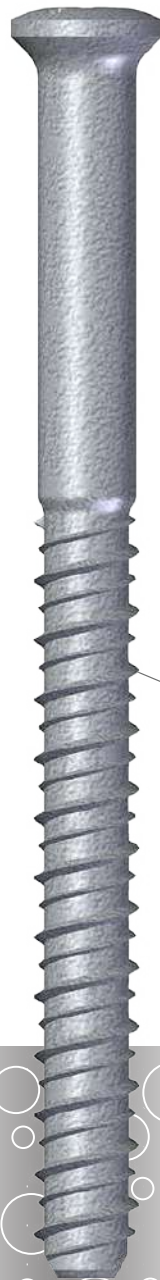

Materiaal
Staal verzinkt met
Magni-Silver coating

**Aanbevolen lengte
in het beton**
Min. 35 mm

Punt
Type BZ (stomp)

Betonnen ondergrond

Product key	Afmetingen			
	Ø	Schroef	Draad	⊠
EFR-63028	6.3	28	28	500
EFR-63075	6.3	75	50	500
EFR-63085	6.3	85	50	500
EFR-63095	6.3	95	50	500
EFR-63105	6.3	105	50	500
EFR-63120	6.3	120	50	500
EFR-63140	6.3	140	50	500
EFR-63160	6.3	160	60	500
EFR-63180	6.3	180	60	500
EFR-63200	6.3	200	60	500

Vorboren

Boordiameter Ø 5.0, 5.2 of 5.5 mm gebruiken om voor te boren. De boordiameter is afhankelijk van de kwaliteit van het beton. Boordiepte: Minimaal 10 mm dieper boren dan de lengte van de bevestiger.

Betonnen ondergrond**EUROFAST® DFCF****15-CYCLI KESTERNICH**

HWH 8 mm kop
Incl. EF-kopmarkering



Materiaal
Staal verzinkt met
Magni-Silver coating

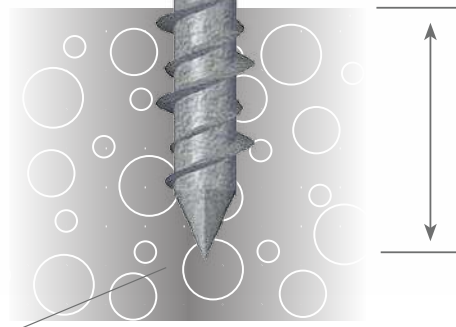

**Aanbevolen lengte
in het beton**
Min. 35 mm

Punt
Nagelpunt

Betonnen ondergrond

Product key	Afmetingen			☒
	Ø	Schroef	Draad	
DFCF-63032	6.3	32	32	1000
DFCF-63041	6.3	41	41	1000
DFCF-63057	6.3	57	57	1000
DFCF-63070	6.3	70	60	1000
DFCF-63081	6.3	81	60	1000
DFCF-63094	6.3	94	60	1000
DFCF-63102	6.3	102	60	1000
DFCF-63127	6.3	127	60	1000
DFCF-63140	6.3	140	60	500
DFCF-63152	6.3	152	60	500
DFCF-63178	6.3	178	60	500
DFCF-63203	6.3	203	60	500
DFCF-63229	6.3	229	60	500
DFCF-63254	6.3	254	60	500
DFCF-63278	6.3	278	60	250
DFCF-63305	6.3	305	60	250

Vorboren

Boordiameter Ø 5.0, 5.2 of 5.5 mm gebruiken om voor te boren. De boordiameter is afhankelijk van de kwaliteit van het beton. Boordiepte: Minimaal 10 mm dieper boren dan de lengte van de bevestiger.

Betonnen ondergrond**OMG HD - DFDS-60****30-CYCLI KESTERNICH**

PH3 bitopname

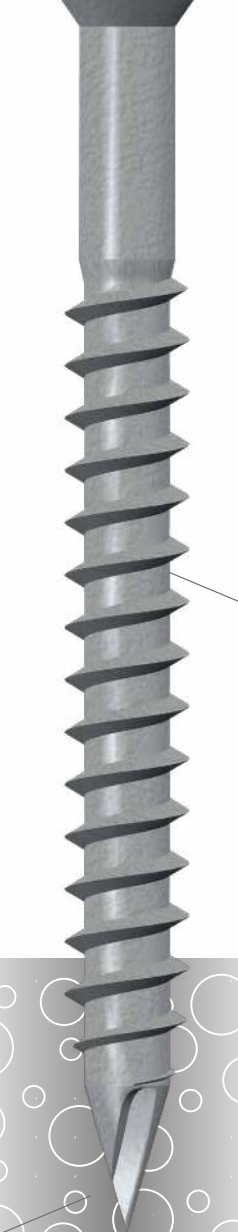

Materiaal
Staal verzinkt met
CR-10 coating

**Aanbevolen lengte
in het beton**
Min. 35 mm

Punt
Ricoh punt

Betonnen ondergrond

Product key	Afmetingen			
	Ø	Schroef	Draad	⊠
DFDS-60030	6.3	30	30	1000
DFDS-60045	6.3	45	45	1000
DFDS-60055	6.3	55	50	1000
DFDS-60075	6.3	75	75	1000
DFDS-60083	6.3	83	75	1000
DFDS-60095	6.3	100	100	1000
DFDS-60115	6.3	115	100	1000
DFDS-60125	6.3	125	100	500
DFDS-60150	6.3	150	100	500
DFDS-60175	6.3	175	100	500
DFDS-60200	6.3	200	100	500
DFDS-60225	6.3	230	100	500
DFDS-60250	6.3	255	100	500
DFDS-60275	6.3	280	100	500
DFDS-60300	6.3	305	100	250
DFDS-60330	6.3	330	100	250
DFDS-60350	6.3	355	100	250
DFDS-60405	6.3	405	100	250
DFDS-60460	6.3	455	125	250
DFDS-60510	6.3	510	125	250
DFDS-60560	6.3	560	125	250
DFDS-60610	6.3	610	125	250

Vorboren

Boordiameter Ø 5.0 mm gebruiken om voor te boren. Boordiepte: Minimaal 10 mm dieper boren dan de lengte van de bevestigiger.

Betonnen ondergrond

OMG CD-10 - DCDF

30-CYCLI KESTERNICH



Vlakke nagelkop



Materiaal
Staal verzinkt met
CR-10 coating

**Aanbevolen lengte
in het beton**
Min. 35 mm

Punt
Diamand punt

Betonnen ondergrond

Product key	Afmetingen			
	Ø	Schroef	Draad	⊠
DCDF-55050	5.5	50	25	1000
DCDF-55065	5.5	65	40	1000
DCDF-55075	5.5	75	50	1000
DCDF-55090	5.5	90	65	1000
DCDF-55100	5.5	100	75	1000
DCDF-55115	5.5	115	90	500
DCDF-55125	5.5	125	100	500
DCDF-55140	5.5	140	115	500
DCDF-55150	5.5	150	125	500
DCDF-55175	5.5	175	150	500
DCDF-55200	5.5	200	175	500
DCDF-55230	5.5	230	205	500
DCDF-55250	5.5	255	225	500
DCDF-55275	5.5	280	250	500
DCDF-55300	5.5	305	275	500

Vorboren

Boordiameter Ø 6.0 mm gebruiken om voor te boren. Boordiepte: Minimaal 10 mm dieper boren dan de lengte van de bevestigiger.

Betonnen ondergrond**EUROFAST® EF-SLAGN****RVS A2**

Betonnen ondergrond

Product key	Klembereik	Afmetingen		
	mm	Ø	Slagniet	⊠
EF-SLAGN4816	11.5 - 13.0	4.8	16	250
EF-SLAGN4825	20.5 - 22.0	4.8	25	250
EF-SLAGN4835	30.5 - 32.0	4.8	35	250
EF-SLAGN4850	45.5 - 47.0	4.8	50	250

Vorboren

Boordiameter Ø 5.0 mm gebruiken om voor te boren. Boordiepte: Dieper boren dan de lengte van de bevestiger.

Tule combinatie voor betonnen ondergrond

EUROFAST® TRPEAS-45

15-CYCLI KESTERNICH

Torx 25 bitopname
Incl. EF-kopmarkering

Instructie video

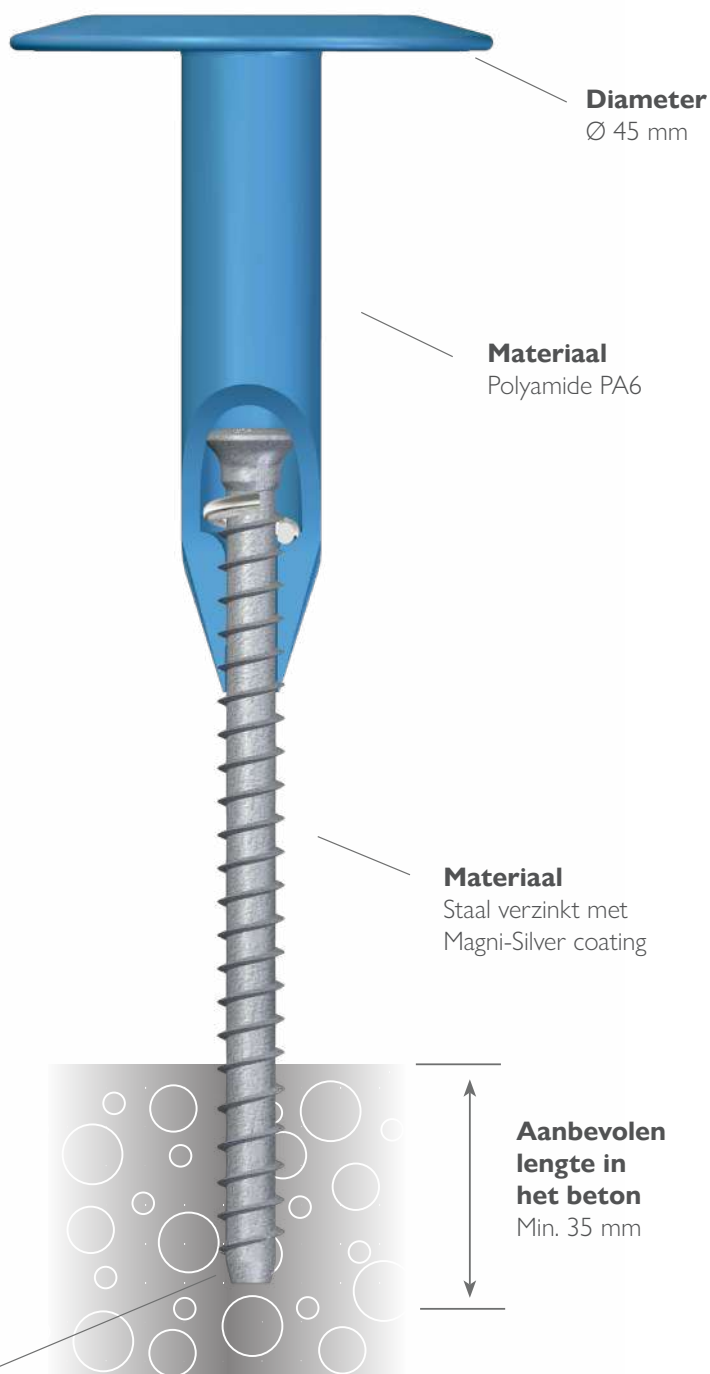
**Diameter**
Ø 45 mm**Materiaal**
Polyamide PA6**Materiaal**
Staal verzinkt met
Magni-Silver coating**Aanbevolen
lengte in
het beton**
Min. 35 mm**Punt**
Type BZ (stomp)

Tule combinatie voor betonnen ondergrond

Product key	Klembereik	Afmetingen		
	mm	Tule	Schroef	⊠
TRPEAS-45-080-105	80 - 105	60	100	250
TRPEAS-45-105-165	105 - 165	90	130	250
TRPEAS-45-165-275	165 - 275	150	180	250
TRPEAS-45-245-350	245 - 350	225	180	125
TRPEAS-45-305-410	305 - 410	285	180	125

AFSCHOTBEVESTIGING

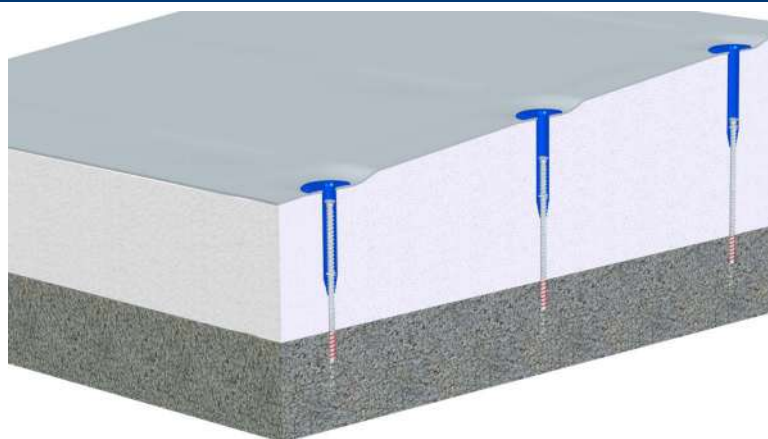

Vorboren

Boordiameter Ø 5.5 mm gebruiken om voor te boren. De boordiameter is afhankelijk van de kwaliteit van het beton. Boordiepte: Minimaal 10 mm dieper boren dan de lengte van de bevestiger. Scan de QR code voor instructies.

Tule combinatie voor betonnen ondergrond

EUROFAST® BTRPEAS-45

15-CYCLI KESTERNICH

Torx 25 bitopname
Incl. EF-kopmarkering

Instructie video

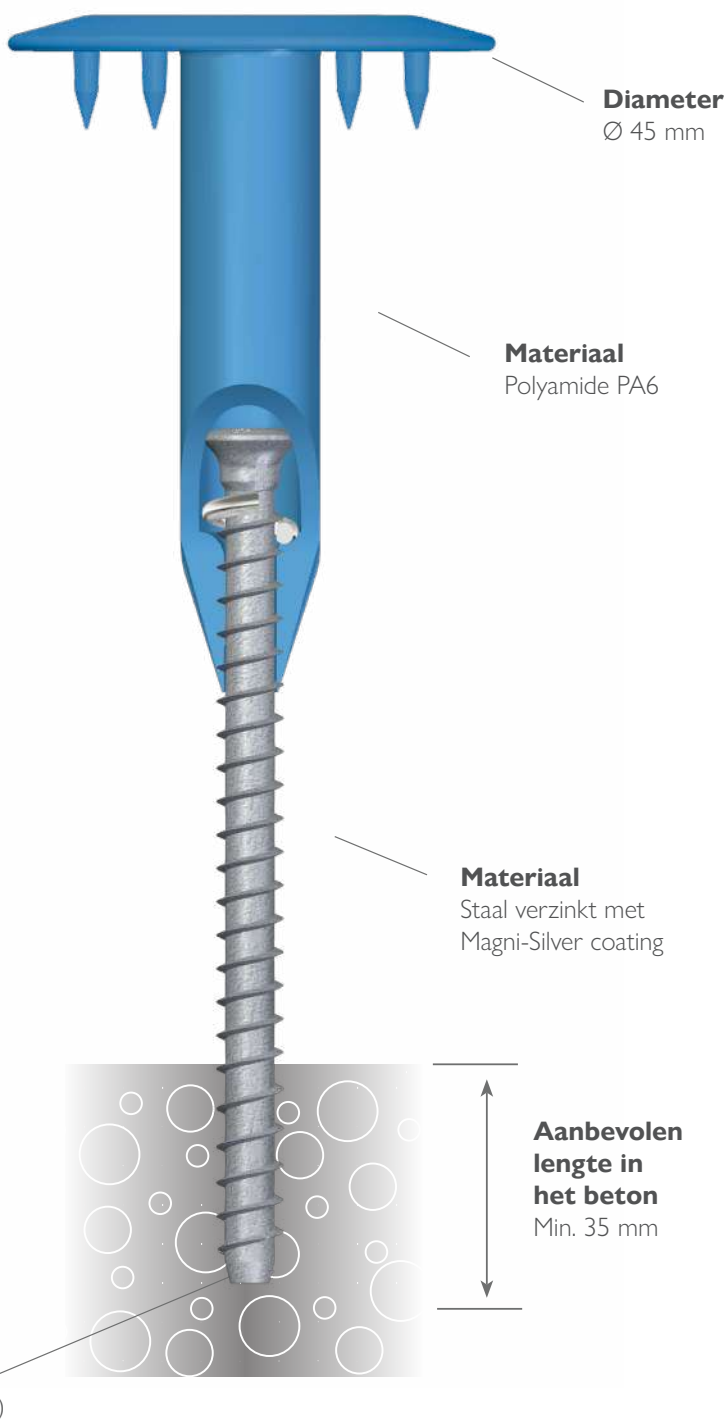

Tule combinatie voor betonnen ondergrond

Product key	Klembereik	Afmetingen		
	mm	Tule	Schroef	⊠
BTRPEAS-45-080-105	80 - 110	60	100	250
BTRPEAS-45-105-165	110 - 165	90	130	250
BTRPEAS-45-165-275	165 - 275	150	180	250
BTRPEAS-45-245-350	245 - 350	225	180	125
BTRPEAS-45-305-410	305 - 410	285	180	125

AFSCHOTBEVESTIGING



Vorboren

Boordiameter \varnothing 5.5 mm gebruiken om voor te boren. De boordiameter is afhankelijk van de kwaliteit van het beton. Boordiepte: Minimaal 10 mm dieper boren dan de lengte van de bevestiger. Scan de QR code voor instructies.

Tule combinatie voor betonnen ondergrond

EUROFAST® TLKEAS-45

15-CYCLI KESTERNICH



Torx 25 bitopname
Incl. EF-kopmarkering



Instructie video



Diameter
Ø 45 mm

Materiaal
Polypropyleen (PP)

Materiaal
Staal verzinkt met
Magni-Silver coating

**Aanbevolen
lengte in
het beton**
Min. 35 mm

Punt
Type BZ (stomp)

Tule combinatie voor betonnen ondergrond

Product key	Klembereik	Afmetingen		
	mm	Tule	Schroef	⊠
TLKEAS-45-085-110	85 - 110	65	100	250
TLKEAS-45-105-160	105 - 160	85	130	250
TLKEAS-45-155-260	155 - 260	135	180	250
TLKEAS-45-245-350	245 - 350	225	180	125
TLKEAS-45-340-445	340 - 445	320	180	125

AFSCHOTBEVESTIGING



Vorboren

Boordiameter Ø 5.5 mm gebruiken om voor te boren. De boordiameter is afhankelijk van de kwaliteit van het beton. Boordiepte: Minimaal 10 mm dieper boren dan de lengte van de bevestiger. Scan de QR code voor instructies.

Tule combinatie voor betonnen ondergrond

EUROFAST® TLKEAS-75

15-CYCLI KESTERNICH



Torx 25 bitopname
Incl. EF-kopmarkering



Instructie video

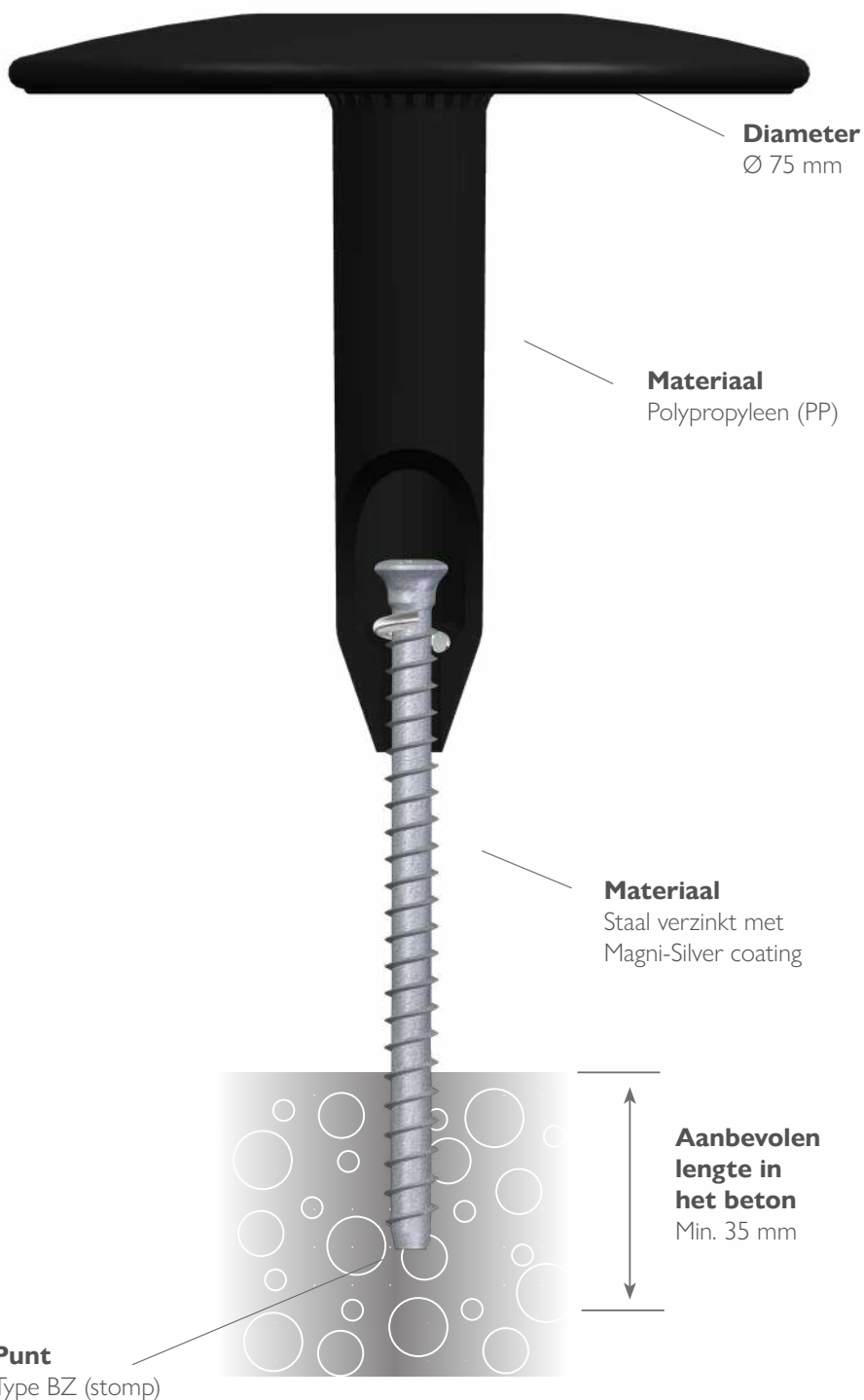

Tule combinatie voor betonnen ondergrond

Product key	Klembereik	Afmetingen		
	mm	Tule	Schroef	⊠
TLKEAS-75-085-110	85 - 110	65	100	250
TLKEAS-75-105-160	105 - 160	85	130	250
TLKEAS-75-155-210	155 - 210	135	130	125
TLKEAS-75-205-315	205 - 315	185	180	125

AFSCHOTBEVESTIGING

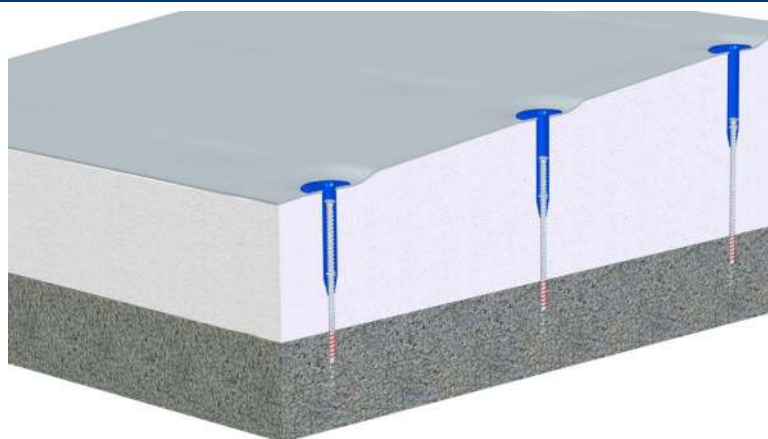

Vorboren

Boordiameter Ø 5.5 mm gebruiken om voor te boren. De boordiameter is afhankelijk van de kwaliteit van het beton. Boordiepte: Minimaal 10 mm dieper boren dan de lengte van de bevestiger. Scan de QR code voor instructies.

Tule combinatie voor betonnen ondergrond

EUROFAST® ISPC

15-CYCLI KESTERNICH



Extra optie

Inslag hulpstuk voor het rechtopstaand verwerken van de ISPC.
ISPC-INSLAG

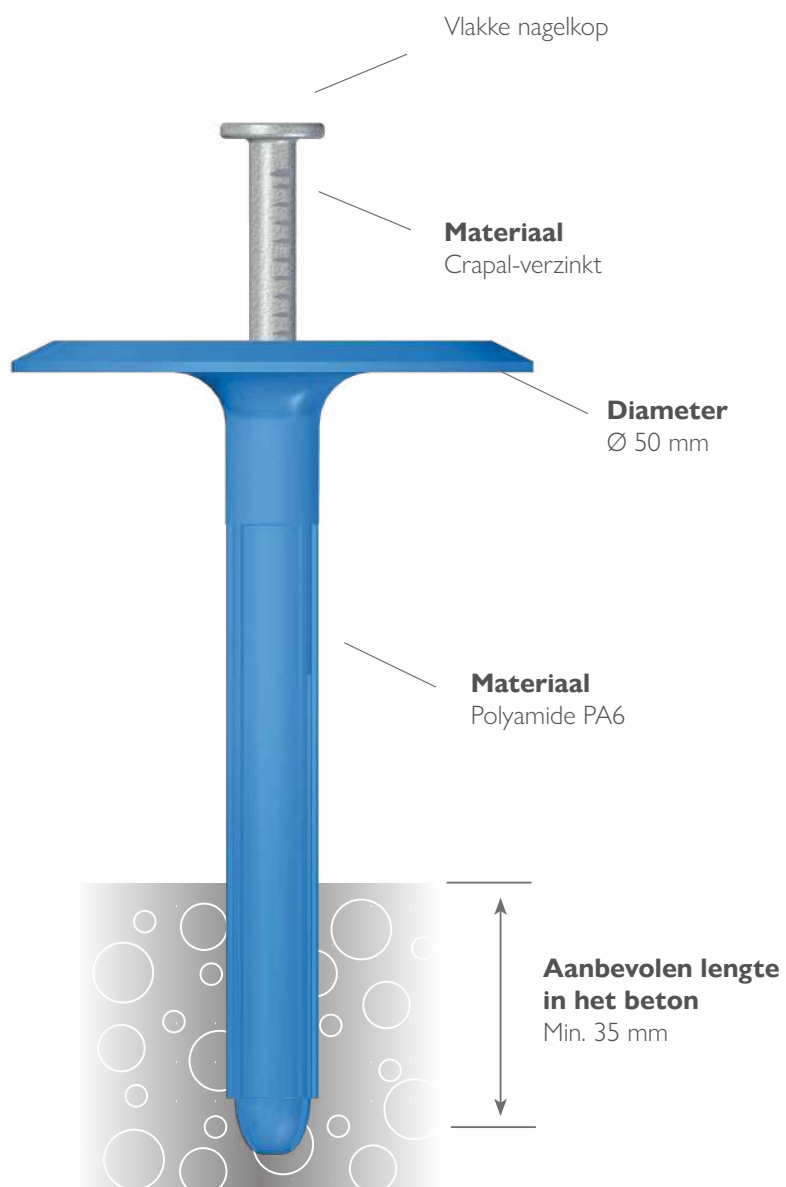

Tule combinatie voor betonnen ondergrond

Product key	Klembereik	Afmetingen		
	mm	Ø	Tule	⊠
ISPC-50045	0 - 10	50	45	250
ISPC-50075	11 - 40	50	75	250
ISPC-50095	41 - 60	50	95	250
ISPC-50115	61 - 80	50	115	250
ISPC-50135	81 - 100	50	135	250
ISPC-50155	101 - 120	50	155	250
ISPC-50175	121 - 140	50	175	250
ISPC-50195	141 - 160	50	195	250
ISPC-50215	161 - 180	50	215	250
ISPC-50245	181 - 210	50	245	125
ISPC-50280	211 - 245	50	280	125
ISPC-50300	246 - 265	50	300	125
ISPC-50330	266 - 295	50	330	125
ISPC-50350	296 - 315	50	350	125
ISPC-50380	316 - 345	50	380	125
ISPC-50410	346 - 375	50	410	125

Vorboren

Boordiameter Ø 8,0 mm gebruiken om voor te boren. Boordiepte: Minimaal 10 mm dieper boren dan de lengte van de tule combinatie.

Kunststof tule

De Eurofast® ISPC is reeds voorzien van een kunststof tule. Deze heeft een diameter van Ø 50 mm. Voor het bevestigen van isolatieplaten of meerlaagse dakbedekkingssystemen past u een ISPC drukverdeelpaat diameter Ø 70 mm toe.

Stapzeker

Dankzij het speciale design van de nagel en de plug biedt de Eurofast® ISPC stapzekerheid.

De nagel komt niet los uit de plug bij correcte verwerking.

Tule combinatie voor betonnen ondergrond

EUROFAST® TLKEFH-45

15-CYCLI KESTERNICH



Torx 25 bitopname
Incl. EF-kopmarkering

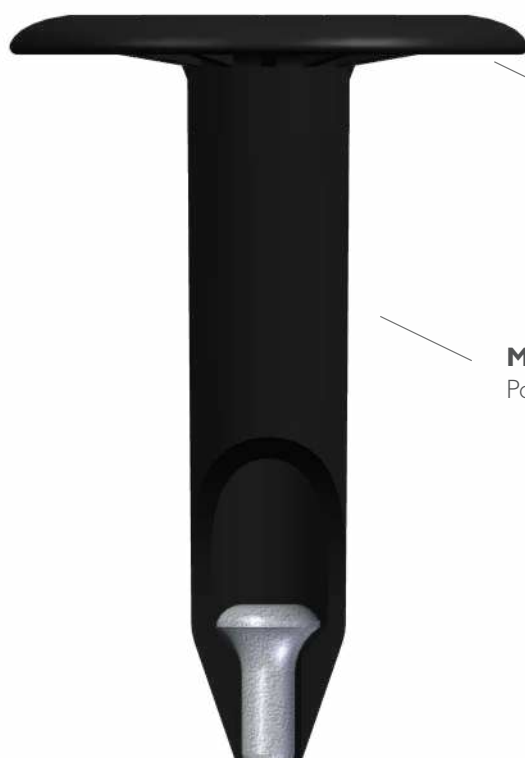

Diameter
Ø 45 mm

Materiaal
Polypropyleen (PP)

Materiaal
Staal verzinkt met
Magni-Silver coating

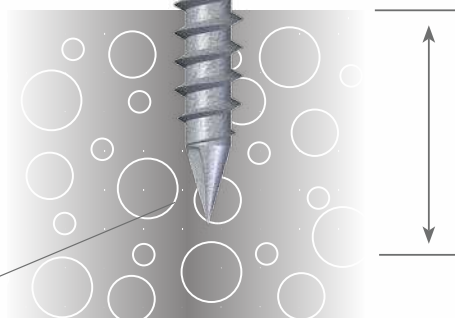

**Aanbevolen
lengte in
het beton**
Min. 35 mm

Punt
Ricoh punt

Tule combinatie voor betonnen ondergrond

Product key	Klembereik	Afmetingen			✉	Product key	Klembereik	Afmetingen			✉
	mm	Tule	Schroef	mm			Tule	Schroef			
* TLKEFHD-45-060	55 - 64	35	80	250	* TLKEFHD-45-250	235 - 254	225	80	125		
* TLKEFHD-45-080	65 - 84	35	100	250	* TLKEFHD-45-270	255 - 274	225	100	125		
* TLKEFHD-45-090	85 - 94	65	80	250	* TLKEFHD-45-300	275 - 304	255	100	125		
* TLKEFHD-45-110	95 - 114	65	100	250	* TLKEFHD-45-330	305 - 334	255	130	125		
* TLKEFHD-45-130	115 - 134	105	80	250	* TLKEFHD-45-360	335 - 364	285	130	125		
* TLKEFHD-45-150	135 - 154	105	100	250	* TLKEFHD-45-400	365 - 404	320	130	125		
* TLKEFHD-45-160	155 - 164	135	80	250	* TLKEFHD-45-430	405 - 434	320	160	125		
* TLKEFHD-45-170	165 - 174	105	130	250	* TLKEFHD-45-470	435 - 474	320	200	125		
* TLKEFHD-45-190	175 - 194	165	80	250	* TLKEFHD-45-520	475 - 524	320	250	125		
* TLKEFHD-45-210	195 - 214	165	100	250	* TLKEFHD-45-570	525 - 574	320	300	125		
* TLKEFHD-45-230	215 - 234	185	100	250							

* Levertijd op aanvraag

Vorboren

Boordiameter Ø 5,0, 5,2 of 5,5 mm gebruiken om voor te boren. De boordiameter is afhankelijk van de kwaliteit van het beton. Boordiepte: Minimaal 10 mm dieper boren dan de lengte van de bevestiger.

Tule combinatie voor betonnen ondergrond

EUROFAST® TLKEFHD-75

15-CYCLI KESTERNICH



Torx 25 bitopname
Incl. EF-kopmarkering

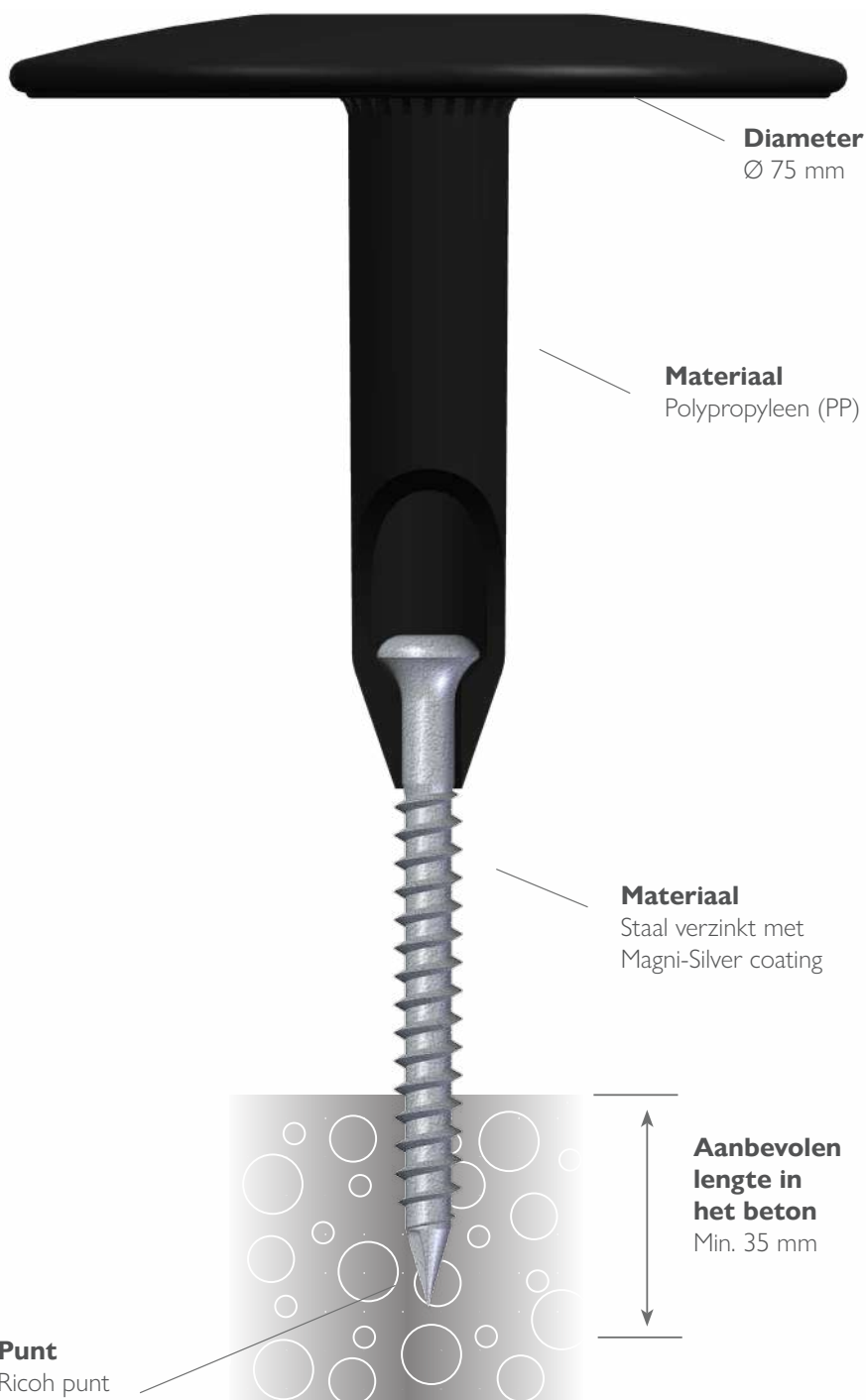

Tule combinatie voor betonnen ondergrond

Product key	Klembereik	Afmetingen			✉	Product key	Klembereik	Afmetingen			✉
	mm	Tule	Schroef				mm	Tule	Schroef		
* TLKEFHD-75-060	55 - 64	35	80	250		* TLKEFHD-75-210	195 - 214	165	100	125	
* TLKEFHD-75-080	65 - 84	35	100	250		* TLKEFHD-75-230	215 - 234	185	100	125	
* TLKEFHD-75-090	85 - 94	65	80	250		* TLKEFHD-75-260	235 - 264	185	130	125	
* TLKEFHD-75-110	95 - 114	65	100	250		* TLKEFHD-75-290	265 - 294	185	160	125	
* TLKEFHD-75-130	115 - 134	105	80	250		* TLKEFHD-75-330	295 - 334	185	200	125	
* TLKEFHD-75-150	135 - 154	105	100	250		* TLKEFHD-75-380	335 - 384	185	250	125	
* TLKEFHD-75-170	165 - 174	105	130	250		* TLKEFHD-75-430	385 - 434	185	300	125	
* TLKEFHD-75-190	175 - 194	165	80	125							

* Levertijd op aanvraag

Vorboren

Boordiameter Ø 5,0, 5,2 of 5,5 mm gebruiken om voor te boren. De boordiameter is afhankelijk van de kwaliteit van het beton. Boordiepte: Minimaal 10 mm dieper boren dan de lengte van de bevestiger.

Tule combinatie voor betonnen ondergrond

EUROFAST® TLKEFR-45

15-CYCLI KESTERNICH



Torx 25 bitopname
Incl. EF-kopmarkering

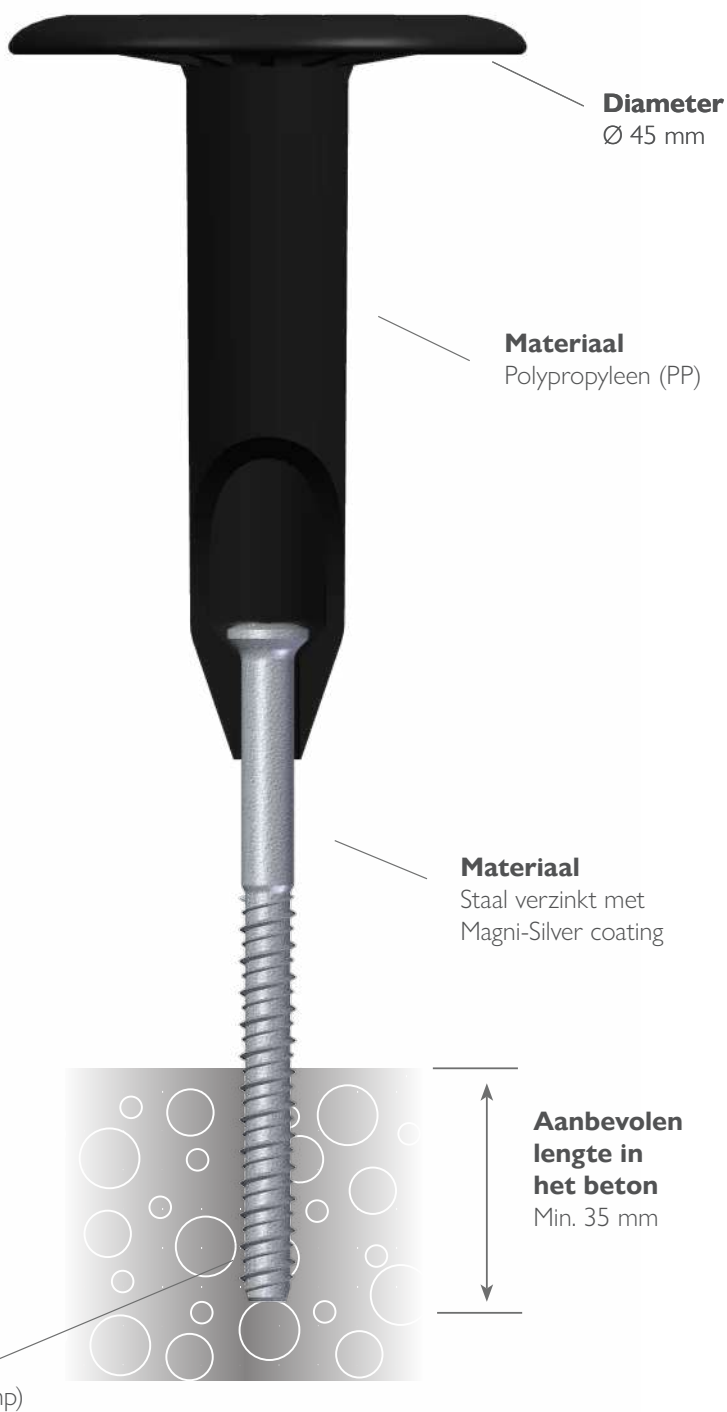

Tule combinatie voor betonnen ondergrond

Product key	Klembereik	Afmetingen		
	mm	Tule	Schroef	⊠
* TLKEFR-45-060	55 - 64	35	75	250
* TLKEFR-45-070	65 - 74	35	85	250
* TLKEFR-45-080	75 - 84	35	95	250
* TLKEFR-45-090	85 - 94	65	75	250
* TLKEFR-45-100	95 - 104	65	85	250
* TLKEFR-45-110	105 - 114	65	95	250
* TLKEFR-45-120	115 - 124	85	85	250
* TLKEFR-45-130	125 - 134	85	95	250
* TLKEFR-45-140	135 - 144	105	85	250
* TLKEFR-45-150	145 - 154	105	95	250
* TLKEFR-45-160	155 - 164	135	75	250
* TLKEFR-45-170	165 - 174	135	85	250

Product key	Klembereik	Afmetingen		
	mm	Tule	Schroef	⊠
* TLKEFR-45-180	175 - 184	135	95	250
* TLKEFR-45-190	185 - 194	165	75	250
* TLKEFR-45-200	195 - 204	165	85	250
* TLKEFR-45-210	205 - 214	165	95	250
* TLKEFR-45-220	215 - 224	185	85	250
* TLKEFR-45-230	225 - 234	185	95	250
* TLKEFR-45-255	235 - 259	185	120	250
* TLKEFR-45-275	260 - 279	185	140	250
* TLKEFR-45-295	280 - 299	185	160	250
* TLKEFR-45-315	300 - 319	185	180	250
* TLKEFR-45-335	320 - 339	185	200	250

* Levertijd op aanvraag

Vorboren

Boordiameter Ø 5,0, 5,2 of 5,5 mm gebruiken om voor te boren. De boordiameter is afhankelijk van de kwaliteit van het beton. Boordiepte: Minimaal 10 mm dieper boren dan de lengte van de bevestiger.

Tule combinatie voor betonnen ondergrond

EUROFAST® TLKEFR-75

15-CYCLI KESTERNICH



Torx 25 bitopname
Incl. EF-kopmarkering

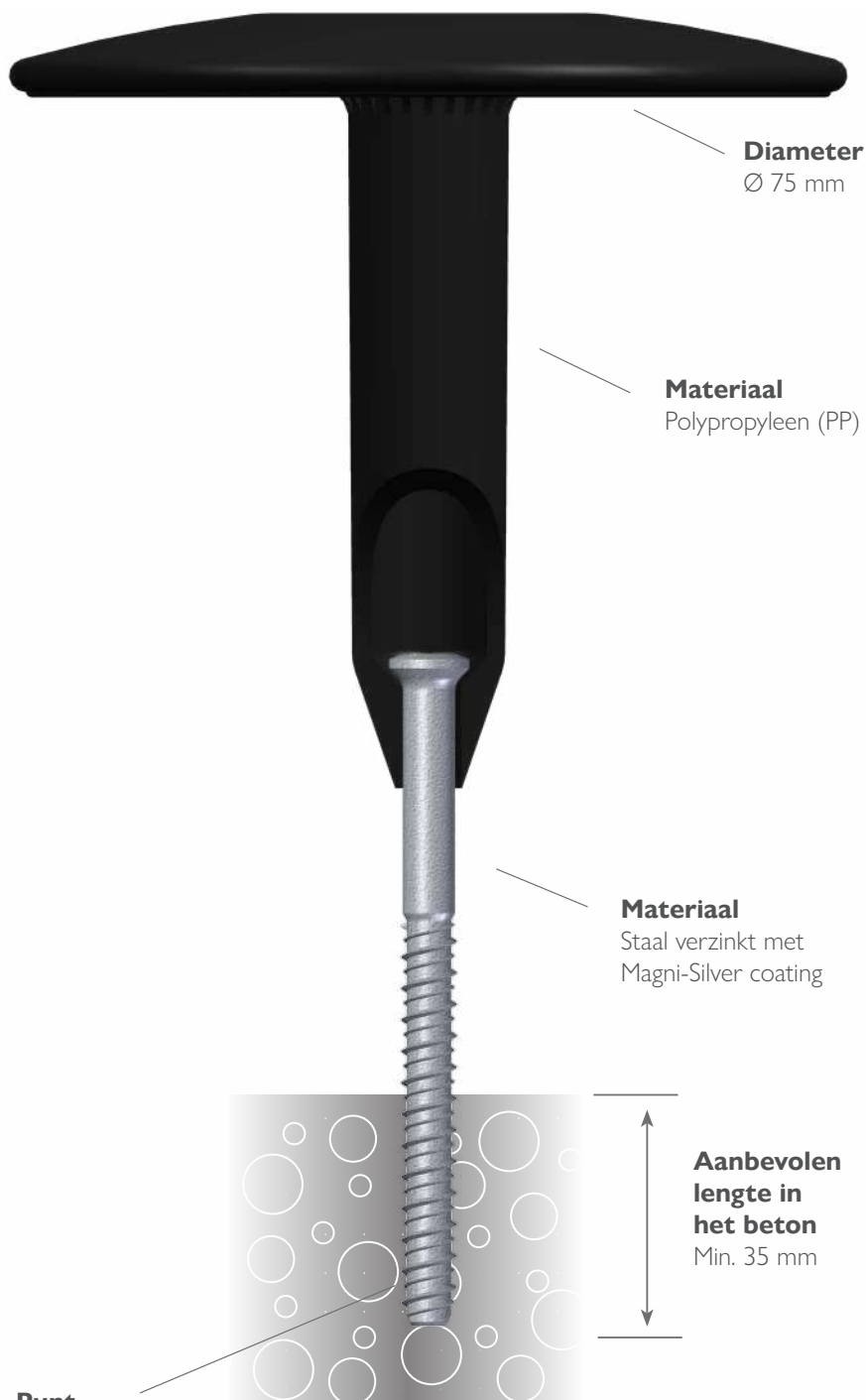

Diameter
Ø 75 mm

Materiaal
Polypropyleen (PP)

Materiaal
Staal verzinkt met
Magni-Silver coating

**Aanbevolen
lengte in
het beton**
Min. 35 mm

Punt
Type BZ (stomp)

Tule combinatie voor betonnen ondergrond

Product key	Klembereik	Afmetingen			✉	Product key	Klembereik	Afmetingen			✉
	mm	Tule	Schroef				mm	Tule	Schroef		
* TLKEFR-75-060	55 - 64	35	75	250	* TLKEFR-75-180	175 - 184	135	95	250		
* TLKEFR-75-070	65 - 74	35	85	250	* TLKEFR-75-190	185 - 194	165	75	250		
* TLKEFR-75-080	75 - 84	35	95	250	* TLKEFR-75-200	195 - 204	165	85	250		
* TLKEFR-75-090	85 - 94	65	75	250	* TLKEFR-75-210	205 - 214	165	95	250		
* TLKEFR-75-100	95 - 104	65	85	250	* TLKEFR-75-220	215 - 224	185	85	250		
* TLKEFR-75-110	105 - 114	65	95	250	* TLKEFR-75-230	225 - 234	185	95	250		
* TLKEFR-75-120	115 - 124	85	85	250	* TLKEFR-75-255	235 - 259	185	120	250		
* TLKEFR-75-130	125 - 134	85	95	250	* TLKEFR-75-275	260 - 279	185	140	250		
* TLKEFR-75-140	135 - 144	105	85	250	* TLKEFR-75-295	280 - 299	185	160	250		
* TLKEFR-75-150	145 - 154	105	95	250	* TLKEFR-75-315	300 - 319	185	180	250		
* TLKEFR-75-160	155 - 164	135	75	250	* TLKEFR-75-335	320 - 339	185	200	250		
* TLKEFR-75-170	165 - 174	135	85	250							

* Levertijd op aanvraag

Vorboren

Boordiameter Ø 5,0, 5,2 of 5,5 mm gebruiken om voor te boren. De boordiameter is afhankelijk van de kwaliteit van het beton. Boordiepte: Minimaal 10 mm dieper boren dan de lengte van de bevestiger.

Tule combinatie voor betonnen ondergrond

EUROFAST® ISPC-A2

RVS A2



Extra optie

Inslag hulpstuk voor het rechtopstaand verwerken van de ISPC. ISPC-INSLAG

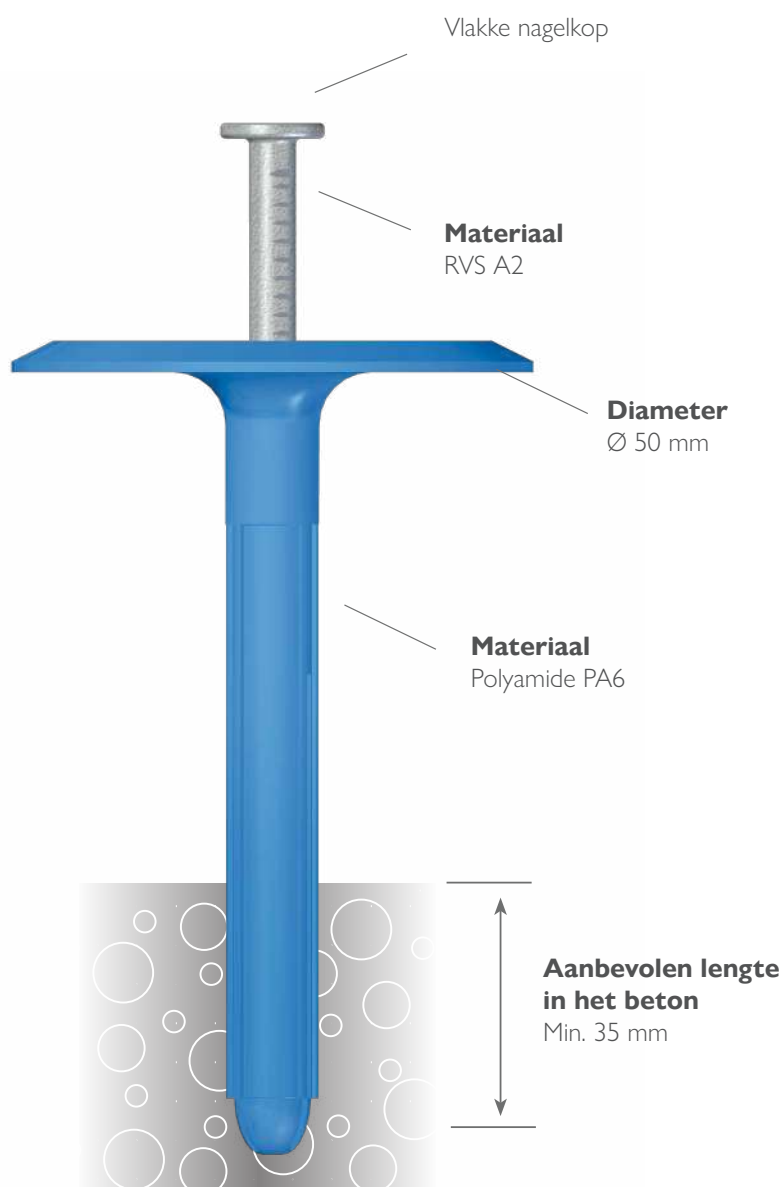

Tule combinatie voor betonnen ondergrond

Product key	Klembereik	Afmetingen		
	mm	Ø	Tule	⊠
ISPC-A2-50045	0 - 10	50	45	250
ISPC-A2-50075	11 - 40	50	75	250
ISPC-A2-50095	41 - 60	50	95	250
ISPC-A2-50115	61 - 80	50	115	250
ISPC-A2-50135	81 - 100	50	135	250
ISPC-A2-50155	101 - 120	50	155	250
ISPC-A2-50175	121 - 140	50	175	250
ISPC-A2-50195	141 - 160	50	195	250
ISPC-A2-50215	161 - 180	50	215	250
ISPC-A2-50245	181 - 210	50	245	125
ISPC-A2-50280	211 - 245	50	280	125
ISPC-A2-50300	246 - 265	50	300	125
ISPC-A2-50330	266 - 295	50	330	125
ISPC-A2-50350	296 - 315	50	350	125
ISPC-A2-50380	316 - 345	50	380	125
ISPC-A2-50410	346 - 375	50	410	125

Vorboren

Boordiameter Ø 8,0 mm gebruiken om voor te boren. Boordiepte: Minimaal 10 mm dieper boren dan de lengte van de tule combinatie.

Kunststof tule

De Eurofast® ISPC is reeds voorzien van een kunststof tule. Deze heeft een diameter van Ø 50 mm. Voor het bevestigen van isolatieplaten of meerlaagse dakbedekkingssystemen past u een ISPC drukverdeelpaat diameter Ø 70 mm toe.

Stapzeker

Dankzij het speciale design van de nagel en de plug biedt de Eurofast® ISPC stapzekerheid.

De nagel komt niet los uit de plug bij correcte verwerking.

Dakbevestigers voor houtwolcementen ondergrond

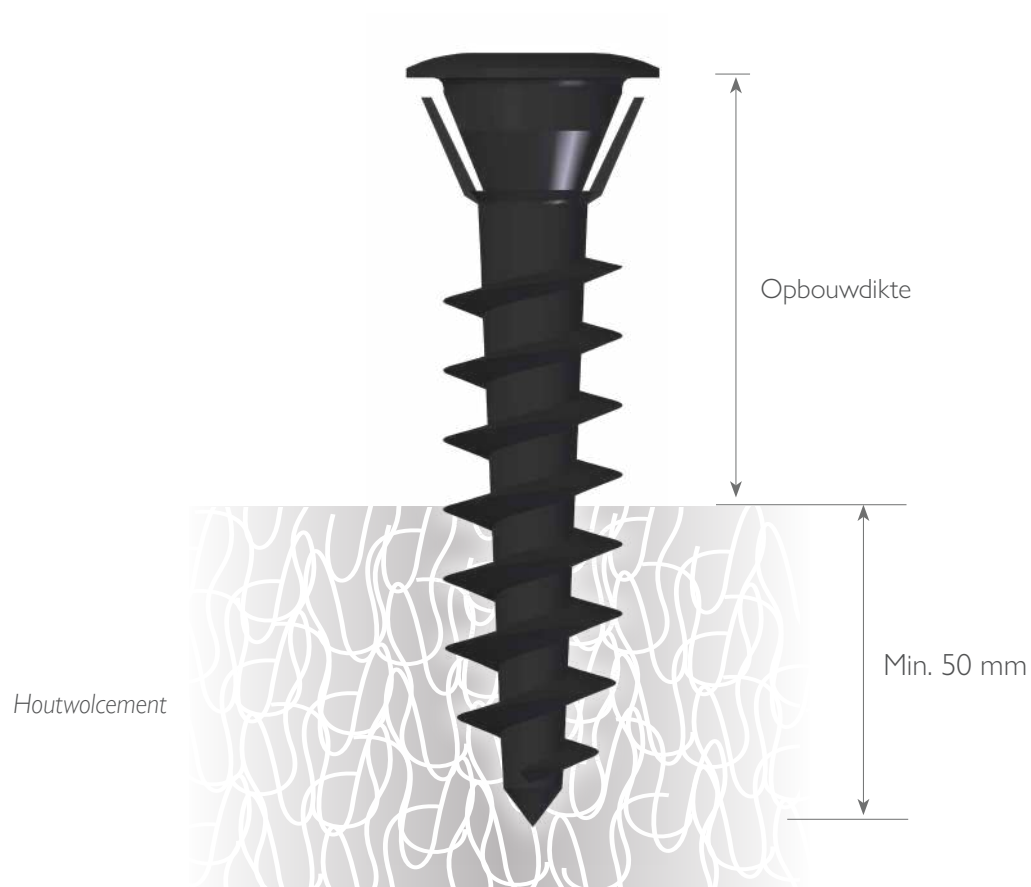

Dakbevestigers voor houtwolcementen ondergrond

Kunststof



Houtwolcement

Voor mechanische bevestiging op houtwolcement adviseren wij je te allen tijde een pull-out test uit te laten voeren. Onze vertegenwoordigers testen voor jou op locatie.

Neem contact met ons op **+31 493 31 58 85** of mail naar sales@eurofastgroup.com voor meer informatie.

Houtwolcementen ondergrond

OMG GYPTEC - GDL

KUNSTSTOF



Robertson bitopname

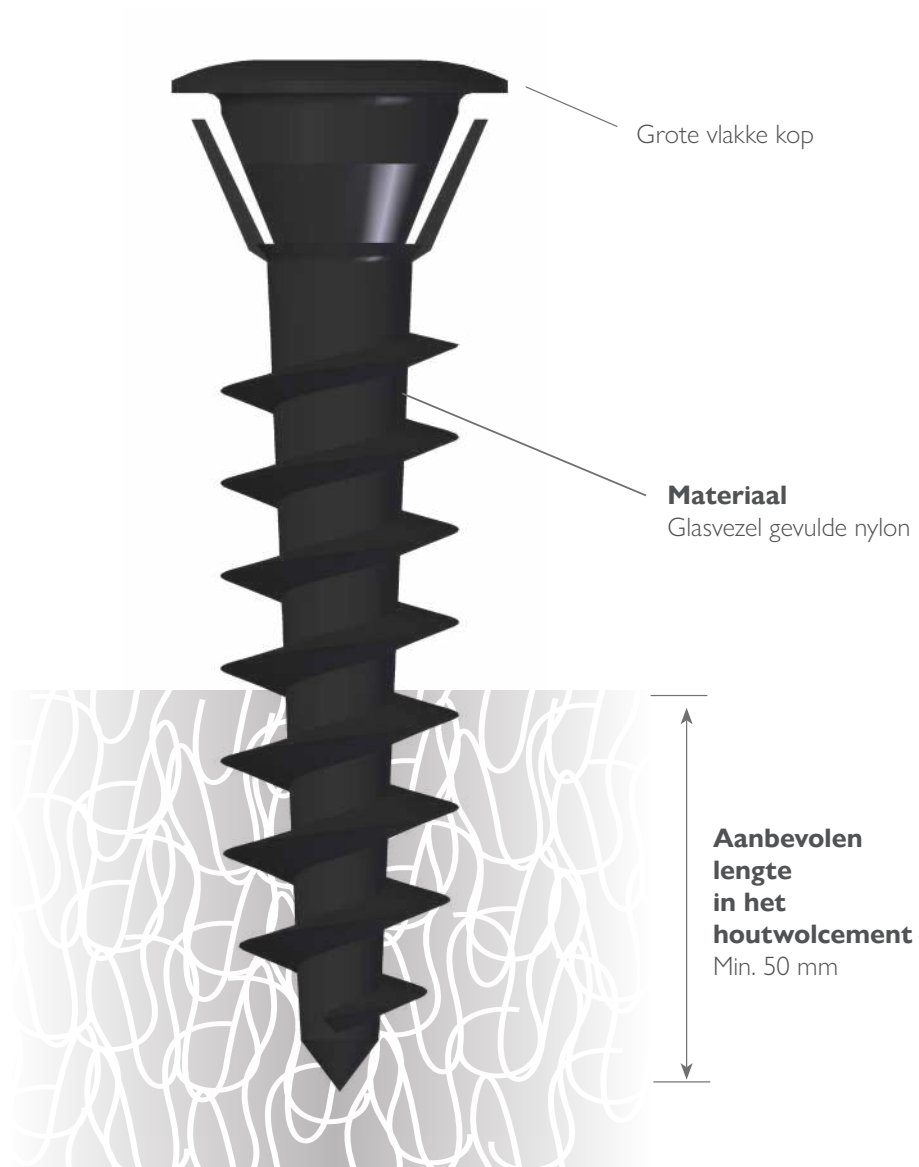

Houtwolcemenen ondergrond

Product key	Afmetingen			
	Ø	Schroef	Draad	✉
GDL-18063	18	60	38	500
GDL-18076	18	75	57	500
GDL-18102	18	100	57	500
GDL-18127	18	125	57	500
GDL-18152	18	150	57	500
GDL-18178	18	175	57	500
GDL-18203	18	200	57	250

Bit

Inclusief bit
OND-TB-GDL



Houtwolcement

Voor mechanische bevestiging op houtwolcement adviseren wij je te allen tijde een pull-out test uit te laten voeren. Onze vertegenwoordigers testen voor jou op locatie.

Neem contact met ons op **+31 493 31 58 85** of mail naar sales@eurofastgroup.com voor meer informatie.

Tules en drukverdeelplaten

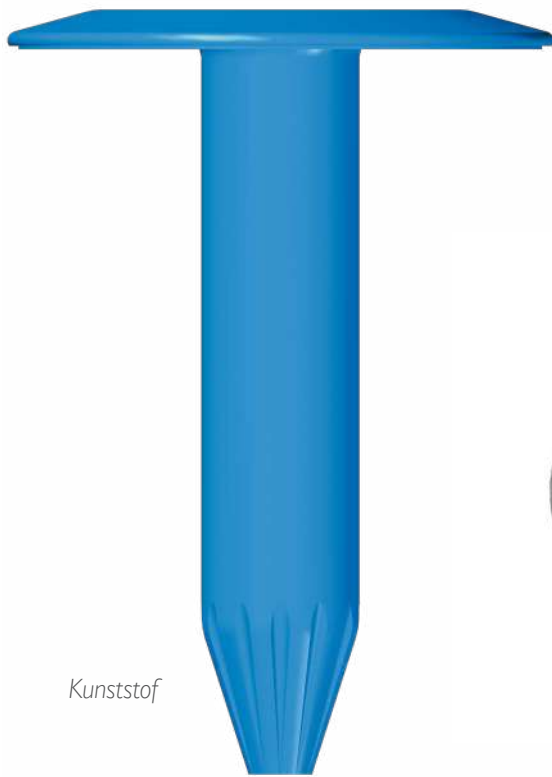

Kunststof



Metaal

Tules en drukverdeelplaten

Tule voor eenlaagse dakbedekkingssystemen - Kunststof

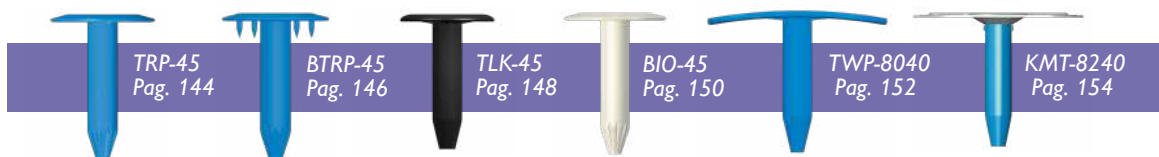

Drukverdeelplaat voor eenlaagse dakbedekkingssystemen - 15-cycli Kesternich



Tule voor isolatie en meerlaagse dakbedekkingssystemen - Kunststof



Drukverdeelplaat voor isolatie en meerlaagse dakbedekkingssystemen - 15-cycli Kesternich



Drukverdeelplaat voor machinale verwerking - 15-cycli Kesternich

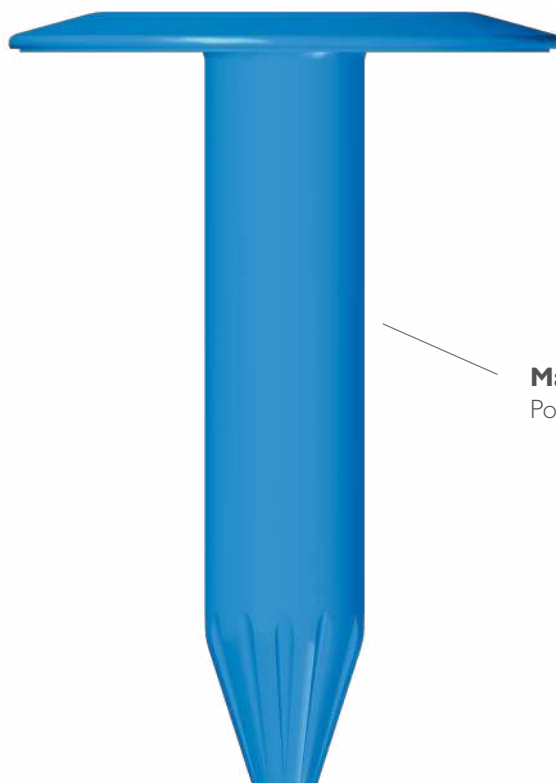

Tule voor eenlaagse dakbedekkingssystemen

EUROFAST® TRP-45**KUNSTSTOF****Diameter**
Ø 45 mm**Materiaal**
Polyamide PA6

Tule voor eenlaagse dakbedekkingssystemen

Product key	Afmetingen		
	Ø	Tule	⊠
TRP-45-L030-250	45	30	250
TRP-45-L060-250	45	60	250
TRP-45-L090-250	45	90	250
TRP-45-L120-250	45	120	250
TRP-45-L135-250	45	135	250
TRP-45-L150-250	45	150	250
TRP-45-L225-125	45	225	125
TRP-45-L285-125	45	285	125

Tule voor eenlaagse dakbedekkingssystemen

EUROFAST® BTRP-45**KUNSTSTOF**

Diameter
Ø 45 mm

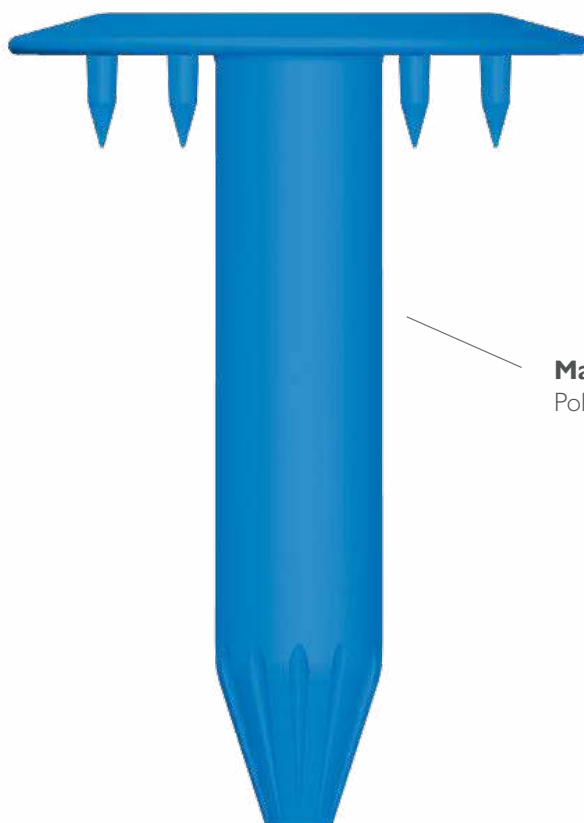

Materiaal
Polyamide PA6

Tule voor eenlaagse dakbedekkingssystemen

Product key	Afmetingen			☒
	Ø	Tule		
BTRP-45-L030-250	45	30		250
BTRP-45-L060-250	45	60		250
BTRP-45-L090-250	45	90		250
BTRP-45-L120-250	45	120		250
BTRP-45-L135-250	45	135		250
BTRP-45-L150-250	45	150		250
* BTRP-45-L225-250	45	225		250
* BTRP-45-L285-250	45	280		250

* Levertijd op aanvraag

Tule voor eenlaagse dakbedekkingssystemen

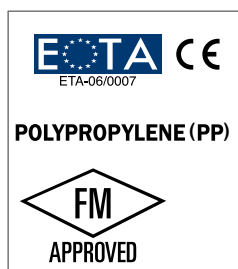
EUROFAST® TLK-45**KUNSTSTOF**

Diameter
Ø 45 mm



Materiaal
Polypropyleen (PP)

Tule voor eenlaagse dakbedekkingssystemen

Product key	Afmetingen			☒
	Ø	Tule		
TLK-45020	45	20		500
TLK-45035	45	35		500
TLK-45065	45	65		500
TLK-45085	45	85		500
TLK-45105	45	105		500
TLK-45135	45	135		250
TLK-45165	45	165		250
TLK-45185	45	185		250
TLK-45225	45	225		125
TLK-45255	45	255		125
TLK-45285	45	285		125
TLK-45320	45	320		125

Tule voor eenlaagse dakbedekkingssystemen

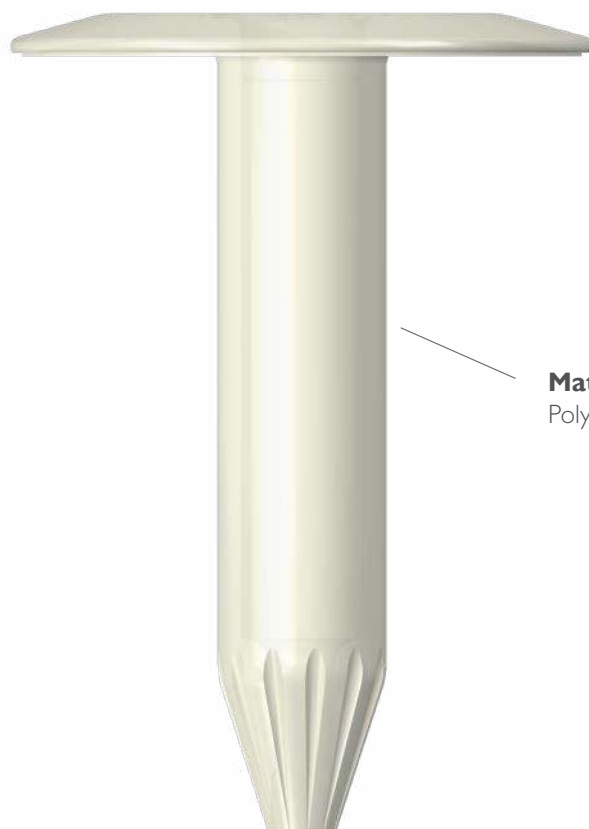
EUROFAST® BIO-45**KUNSTSTOF****Diameter**
Ø 45 mm**Materiaal**
Polyamide PA410

Tule voor eenlaagse dakbedekkingssystemen

Product key	Afmetingen		
	Ø	Tule	⊠
BIO-45-L060-250	45	60	250
BIO-45-L090-250	45	90	250
BIO-45-L120-250	45	120	250

Bio tube

De Eurofast® BIO-45 is gemaakt van een biobased materiaal. De tule is recyclebaar en kan samen met de dakbedekking gerecycled worden. Neem contact met ons op

+31 493 31 58 85 of mail naar sales@eurofastgroup.com voor meer informatie.

Tule voor eenlaagse dakbedekkingssystemen

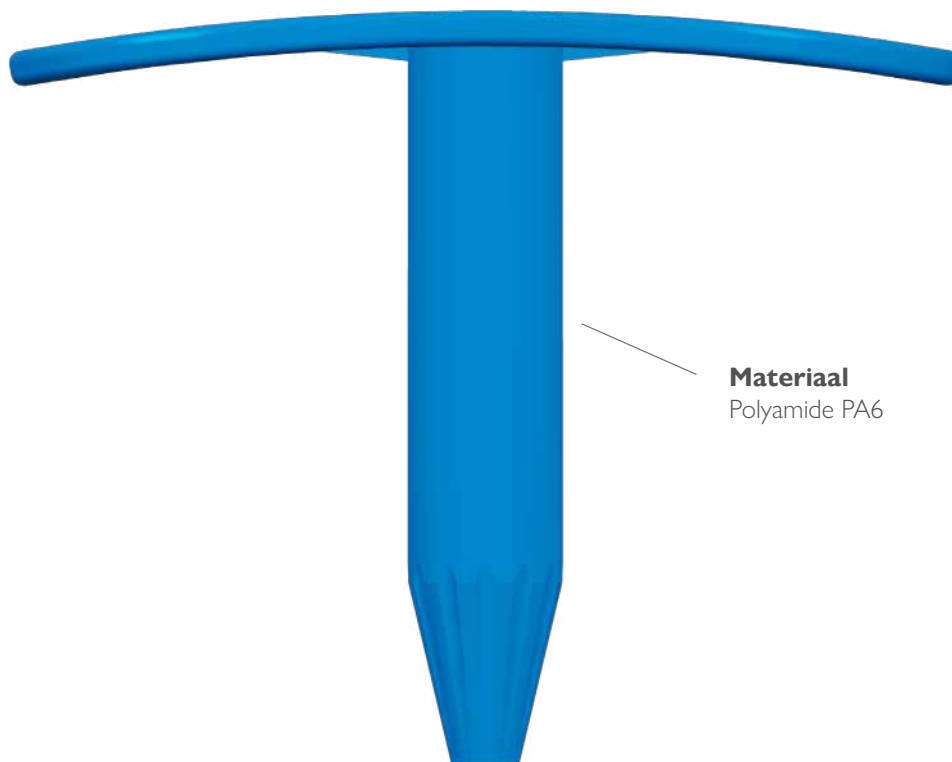
EUROFAST® TWP-8040**KUNSTSTOF****Afmeting**
80 x 40 mm**Materiaal**
Polyamide PA6

Tule voor eenlaagse dakbedekkingssystemen

Product key	Afmetingen			☒
	Ø	Tule		
TWP-8040L030-250	80 x 40	30		250
TWP-8040L060-250	80 x 40	60		250
TWP-8040L090-250	80 x 40	90		250
TWP-8040L120-250	80 x 40	120		250
TWP-8040L150-250	80 x 40	150		250

Tule voor eenlaagse dakbedekkingssystemen

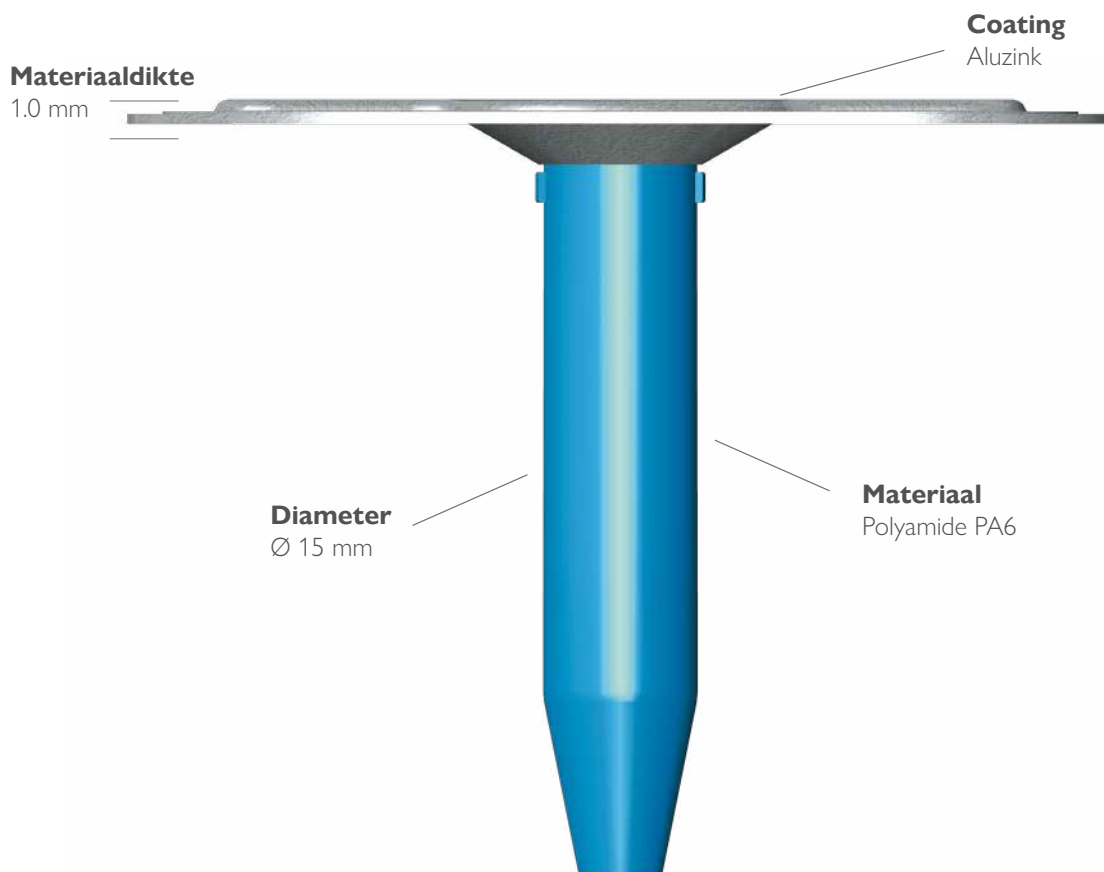
EUROFAST® KMT-8240**KUNSTSTOF**
15-CYCLI KESTERNICH**Afmeting drukverdeelplaat**
82 x 40 mm

Tule voor eenlaagse dakbedekkingssystemen

Product key	Afmetingen			
	Ø DVP	Ø Tule	Tule	⊠
KMT-15035D82	82 x 40	15	35	250
KMT-15085D82	82 x 40	15	85	250
KMT-15135D82	82 x 40	15	135	250
KMT-15185D82	82 x 40	15	185	250
KMT-15255D82	82 x 40	15	255	250
KMT-15285D82	82 x 40	15	285	250
KMT-15320D82	82 x 40	15	320	250

Drukverdeelplaat voor eenlaagse dakbedekkingssystemen

EUROFAST® DVP

15-CYCLI KESTERNICH

Aluzinc

Z Zachte isolatie

H Harde isolatie

G Geen isolatie



H

Certificering	DVP-EF-5010N	☒
 ETA-06/0007 	Afmeting	Ø 50 mm
	Gat	Ø 6.3 mm
	Materiaaldikte	1.0 mm
		1000st



Z

Certificering	DVP-EF-5010D	☒
 ETA-06/0007 	Afmeting	Ø 50 mm
	Gat	Ø 6.3 mm
	Materiaaldikte	1.0 mm
		1000st



G

Certificering	DVP-EF-51N	☒
 ETA-06/0007 	Afmeting	Ø 51 mm
	Gat	Ø 6.7 mm
	Materiaaldikte	0.84 mm
		1000st



G

Certificering	DVP-DF-51N	☒
 ETA-09/0337 	Afmeting	Ø 51 mm
	Gat	Ø 6.7 mm
	Materiaaldikte	0.7 mm
		1000st



H

Certificering	DVP-EFB-51NS	☒
 ETA-06/0007 	Afmeting	Ø 51 mm
	Gat	Ø 5.4 mm
	Materiaaldikte	0.84 mm
		1000st



H

Certificering	DVP-DFB-51N	☒
 ETA-09/0337 	Afmeting	Ø 51 mm
	Gat	Ø 6.7 mm
	Materiaaldikte	0.7 mm
		1000st



Certificering	DVP-GDL-51N	☒
 ETA-09/0337 	Afmeting	Ø 51 mm
	Gat	Ø 18 mm
	Materiaaldikte	0.7 mm
		500st

Drukverdeelplaat voor eenlaagse dakbedekkingssystemen

15-CYCLI KESTERNICH

Aluzinc

Z Zachte isolatie

H Harde isolatie

G Geen isolatie



H

Certificering	DVP-EF-8040N	☒	
 ETA-06/0007 	Afmeting	80 x 40 mm	500st
	Gat	Ø 6.5 mm	
	Materiaaldikte	1.0 mm	



Z

Certificering	DVP-EF-8040D	☒	
 ETA-06/0007 	Afmeting	80 x 40 mm	500st
	Gat	Ø 6.5 mm	
	Materiaaldikte	1.0 mm	



Z

Certificering	DVP-DF-8240D	☒	
 ETA-06/0007 	Afmeting	82 x 40 mm	100st
	Gat	Ø 7.0 mm	
	Materiaaldikte	1.0 mm	



Z

Certificering	DVP-DF-8240R	☒	
 ETA-06/0007 	Afmeting	82 x 40 mm	100st
	Gat	Ø 7.0 mm	
	Materiaaldikte	1.0 mm	



Z

Certificering	DVP-DFB8240D	☒	
 ETA-06/0007 	Afmeting	82 x 40 mm	700st
	Gat	Ø 7.0 mm	
	Materiaaldikte	1.0 mm	



G

Certificering	DVP-DF-8240H	☒	
 ETA-06/0007 	Afmeting	82 x 40 mm	80st
	Gat	Ø 7.0 mm	
	Materiaaldikte	1.0 mm	



G

Certificering	DVP-DF8240XH	☒	
 ETA-06/0007 	Afmeting	82 x 40 mm	90st
	Gat	Ø 7.0 mm	
	Materiaaldikte	1.0 mm	



G

Certificering	DVP-EF8240XH	☒	
 ETA-06/0007 	Afmeting	82 x 40 mm	90st
	Gat	Ø 4.85 mm	
	Materiaaldikte	1.0 mm	

Drukverdeelplaat voor eenlaagse dakbedekkingssystemen

15-CYCLI KESTERNICH

Aluzinc

Z Zachte isolatie

H Harde isolatie

G Geen isolatie

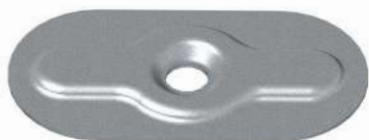

H

Certificering	DVP-EF-8040N-9		☒
 ETA-06/0007 	Afmeting	80 x 40 mm	500st
	Gat	Ø 9.0 mm	
	Materiaaldikte	1.0 mm	



Certificering	EDF-BAR-F of FB		☒
 ETA-06/0007 	Afmeting	2250 x 30 mm	10st
	Gat	Ø 4.85 / 8.0 mm	
	Materiaaldikte	1.0 mm	

KUNSTSTOF



Z

Certificering	DVP-DFK-51N		☒
 ETA-09/0337 	Afmeting	Ø 50 mm	1000st
	Gat	Ø 6.8 mm - Tri-lock	
	Materiaaldikte	1.2 mm - Nylon	

Toepassing:
bevestiging van
scheidingslagen.



G

Certificering	DVP-EF-4010N		☒
 ETA-06/0007 	Afmeting	Ø 40 mm	1000st
	Gat	Ø 6.0 mm	
	Materiaaldikte	1.0 mm	

Tule voor isolatie en meerlaagse dakbedekkingssystemen

EUROFAST® TLK-75

KUNSTSTOF



Diameter
Ø 75 mm



Materiaal
Polypropyleen (PP)

Tule voor isolatie en meerlaagse dakbedekkingssystemen

Product key	Afmetingen		
	Ø	Tule	⊠
TLK-75035	75	35	250
TLK-75065	75	65	250
TLK-75085	75	85	250
TLK-75105	75	105	250
TLK-75135	75	135	250
TLK-75165	75	165	250
TLK-75185	75	185	250

Drukverdeelplaat voor isolatie en meerlaagse dakbedekkingssystemen

EUROFAST® DVP

15-CYCLI KESTERNICH

Aluzinc

Z Zachte isolatie**H** Harde isolatie**G** Geen isolatie**H**

Certificering	DVP-EF-7005N	☒	
 ETA-06/0007 	Afmeting	Ø 70 mm	1000st
	Gat	Ø 5.1 mm	
	Materiaaldikte	0.5 mm	

**H**

Certificering	DVP-EF7005N5	☒	
 ETA-06/0007 	Afmeting	Ø 70 mm	500st
	Gat	Ø 5.1 mm	
	Materiaaldikte	0.5 mm	

**Z**

Certificering	DVP-EF-7005D	☒	
 ETA-06/0007 	Afmeting	Ø 70 mm	1000st
	Gat	Ø 5.0 mm	
	Materiaaldikte	0.5 mm	

**H**

Certificering	DVP-EF-7007N	☒	
 ETA-06/0007 	Afmeting	Ø 70 mm	1000st
	Gat	Ø 6.0 mm	
	Materiaaldikte	0.7 mm	

**H**

Certificering	DVP-EF7007N5	☒	
 ETA-06/0007 	Afmeting	Ø 70 mm	500st
	Gat	Ø 6.0 mm	
	Materiaaldikte	0.7 mm	

**G**

Certificering	DVP-EF-7007D	☒	
 ETA-06/0007 	Afmeting	Ø 70 mm	500st
	Gat	Ø 6.0 mm	
	Materiaaldikte	0.7 mm	

**G**

Certificering	DVP-EF-7007H	☒	
 ETA-06/0007 	Afmeting	Ø 70 mm	500st
	Gat	Ø 6.0 mm	
	Materiaaldikte	0.7 mm	

Drukverdeelplaat voor isolatie en meerlaagse dakbedekkingssystemen

15-CYCLI KESTERNICH

Aluzinc

Z Zachte isolatie

H Harde isolatie

G Geen isolatie

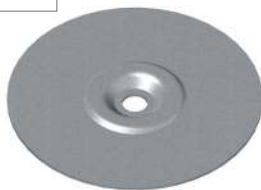

H

Certificering	DVP-EF-7010N	✉
 ETA-06/0007 	Afmeting	Ø 70 mm
	Gat	Ø 6.5 mm
	Materiaaldikte	1.0 mm
		500st



Z

Certificering	DVP-EF-7010D	✉
 ETA-06/0007 	Afmeting	Ø 70 mm
	Gat	Ø 6.5 mm
	Materiaaldikte	1.0 mm
		500st



Certificering	DVP-DF-73N	✉
 ETA-09/0337 	Afmeting	Ø 73 mm
	Gat	Ø 6.5 mm
	Materiaaldikte	0.7 mm
		1000st



Certificering	DVP-GDL-73N	✉
 ETA-09/0337 	Afmeting	Ø 73 mm
	Gat	Ø 18 mm
	Materiaaldikte	0.7 mm
		500st



Certificering	DVP-ISPC-70N	✉
 ETA-06/0007 	Afmeting	Ø 70 mm
	Gat	Ø 12 mm
	Materiaaldikte	0.5 mm
		250st

KUNSTSTOF		
		Z
Certificering	DVP-DFK-73N	✉
 ETA-09/0337 	Afmeting	Ø 75 mm
	Gat	Ø 6.8 mm - Tri-lock
	Materiaaldikte	1.2 mm - Polypropyleen (PP)
		1000st

Drukverdeelplaat voor machinale verwerking

EUROFAST® DVP



15-CYCLI KESTERNICH

Aluzinc





Certificering	DVP-EF-7070D		☒
 ETA-06/0007 	Afmeting	70 x 70 mm	100st
	Gat	Ø 4.85 mm	
	Materiaaldikte	1.0 mm	





Certificering	DVP-EF-8240D		☒
 ETA-06/0007 	Afmeting	82 x 40 mm	100st
	Gat	Ø 4.85 mm	
	Materiaaldikte	1.0 mm	



Certificering	DVPEFZK8240D		☒
 ETA-06/0007  	Afmeting	82 x 40 mm	90st
	Gat	Ø 4.85 mm	
	Materiaaldikte	1.0 mm	



Certificering	DVP-EFB8240D		☒
 ETA-06/0007 	Afmeting	82 x 40 mm	35st
	Gat	Ø 4.85 mm	
	Materiaaldikte	1.0 mm	

Hout ≤ 15 mm en staal ≤ 0.6 mm constructies

EUROFAST® Peel Rivet



Product key	Klembereik	Afmetingen		
	mm	Ø	Plug	⊠
1130064025	10	6.4	25	100
1130064038	25	6.4	38	100
* 1130064050	40	6.4	50	500
* 1130064080	70	6.4	80	250
* 1130064100	90	6.4	100	250
* 1130064120	110	6.4	120	250
* 1130064150	140	6.4	150	250
* 1130064175	165	6.4	175	200

* Levertijd op aanvraag



Vorboren

Boordiameter Ø 7.0 mm gebruiken om voor te boren.

Statische uittrekwaarde

Er mag gerekend worden met een statische uittrekwaarde van 3500N en een afschuifwaarde van 2450N, getest volgens EN ISO14589.

Universele toepassingen

Afdekdop



Extra optie

Overige RAL kleuren op aanvraag.
Minimale afname: 5.000st

Product key	Afmetingen			
	Ø	Plug	RAL	☒
5040159002	4.0	15	9002	500
5040309002	4.0	30	9002	500
5040159007	4.0	15	9007	500
5040309007	4.0	30	9007	500
5040159010	4.0	15	9010	500
5040309010	4.0	30	9010	500
5040150000	4.0	15	-	500
5040300000	4.0	30	-	500
5060309010	6.0	30	9010	500

Lood voegklem



Product key				
				☒
2302000025				25
2302000050				50

Universele toepassingen

EUROFAST® Nagels



Materiaal
Staal

ASFALTNAGEL Product key	Afmetingen			
	Ø	Nagel	Gewicht	☒
RAN-30015-01	3.0	15	1000	979
RAN-30015-05	3.0	15	5000	4895
RAN-30020-01	3.0	20	1000	706
RAN-30020-05	3.0	20	5000	3530
RAN-30025-01	3.0	25	1000	610
RAN-30025-05	3.0	25	5000	3050
RAN-30030-01	3.0	30	1000	501
RAN-30030-05	3.0	30	5000	2505
RAN-30040-01	3.0	40	1000	417
RAN-30040-05	3.0	40	5000	2085
RAN-30050-05	3.0	50	5000	1685



Materiaal
Aluminium

LEINAGEL Product key	Afmetingen			
	Ø	Nagel	Gewicht	☒
RALN-38060	3.8	60	2000	980
RALN-38065	3.8	65	2000	920
RALN-38070	3.8	70	2000	860
RALN-38080	3.8	80	2000	760
RALN-38100	3.8	100	2000	620
RALN-50125	5.0	125	2000	300



Materiaal
Staal

TRIMNAGEL Product key	Afmetingen			
	Ø	Nagel	Gewicht	☒
RTN-38025	3.8	25	1778	1000
RTN-38025-01	3.8	25	1000	560
RTN-38032	3.8	32	2268	1000
RTN-38032-01	3.8	32	1000	440



Materiaal
RVS A2

TRIMNAGEL Product key	Afmetingen			
	Ø	Nagel	Gewicht	☒
RTN-SR-36032-01	3.6	32	1000	540

Universele toepassingen

EUROFAST® Speedpluggen



Product key	Afmetingen			☒
	Ø	Plug		
4550005030	5.0	30		200
4550005040	5.0	40		200
4550005050	5.0	50		200
4550006030	6.0	30		200
4550006035	6.0	35		200
4550006040	6.0	40		200
4550006050	6.0	50		200
4550006060	6.0	60		200
4550006080	6.0	80		200
4550006100	6.0	100		100
4550008060	8.0	60		100
4550008080	8.0	80		100
4550008100	8.0	100		100
4550008120	8.0	120		100
4550008140	8.0	140		100



Product key	Afmetingen			☒
	Ø	Plug		
4551006040	6.0	40		200
4551006050	6.0	50		200
4551006060	6.0	60		200
4551006080	6.0	80		200
4551006100	6.0	100		100
4551008060	8.0	60		100
4551008080	8.0	80		100
4551008100	8.0	100		100
4551008120	8.0	120		100
4551008140	8.0	140		100

Universele toepassingen

EUROFAST® Afdichtingsband

Product key	Omschrijving
	2304000004 <ul style="list-style-type: none"> • Butylband 4 mm BEAD • Grijs • 12 meter p/rol • Doos à 30 rollen
	2304000008 <ul style="list-style-type: none"> • Butylband 6 mm BEAD • Grijs • 8 meter p/rol • Doos à 22 rollen
	2304000007 <ul style="list-style-type: none"> • Butylband 8 mm BEAD • Grijs • 6 meter p/rol • Doos à 22 rollen
	2304000001 <ul style="list-style-type: none"> • Butylband 3 mm x 9 mm • Grijs • 15 meter p/rol • Doos à 22 rollen
	2304000009 <ul style="list-style-type: none"> • Butylband 5 mm x 6 mm • Grijs • 9.6 meter p/rol • Doos à 22 rollen
	2304000005 <ul style="list-style-type: none"> • Butylband 4 mm x 18 mm • Grijs U-shape • 12 meter p/rol • Doos à 16 rollen
	2304000010 <ul style="list-style-type: none"> • Polyband 1 mm x 50 mm • Wit • 35 meter p/rol • Doos à 6 rollen

Universele toepassingen

Reparatie materiaal

Product key	Omschrijving
	1602000118 Stalen aandrukrol 40 mm
	2302021000 Reparatie folie wit, rol ± 15 cm x 15.2 meter
	2302021100 Reparatie folie zwart, rol ± 15 cm x 15.2 meter
	2302021010 Reparatie folie wit, rol ± 30 cm x 15.2 meter
	2302021110 Reparatie folie zwart, rol ± 30 cm x 15.2 meter
	2302021300 Schuurpad, 26 x 12 cm
	2302021400 Schuurpad-houder
	2302022050 Reiniger, spray-flacon 0.5 Liter

Gereedschap & toebehoren

EUROFAST® SDS-plus boor

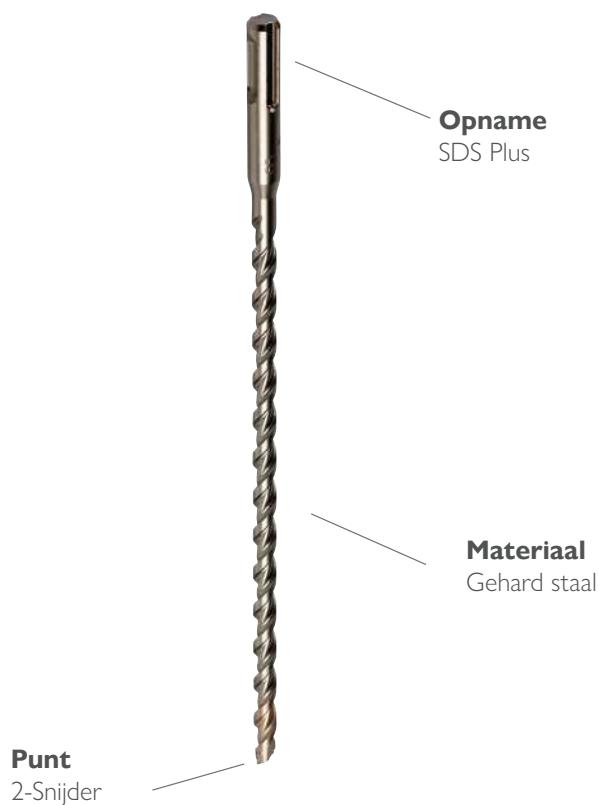

Product key	Afmetingen			
	Ø	Totaal	Nuttig	☒
0121050110	5.0	110	50	1
0121050160	5.0	160	100	1
0121050210	5.0	210	150	1
0121050260	5.0	260	200	1
0121050310	5.0	310	250	1
0121050410	5.0	410	350	1
0121055110	5.5	110	50	1
0121055160	5.5	160	100	1
0121055210	5.5	210	150	1
0121055260	5.5	260	200	1
0121055310	5.5	310	250	1
0121055350	5.5	350	300	1
0121055410	5.5	410	350	1
0121055600	5.5	600	540	1
0121060110	6.0	110	50	1
0121060160	6.0	160	100	1

Product key	Afmetingen			
	Ø	Totaal	Nuttig	☒
0121060210	6.0	210	150	1
0121060260	6.0	260	200	1
0121060310	6.0	310	250	1
0121060460	6.0	460	400	1
0121060600	6.0	600	540	1
0121080110	8.0	110	50	1
0121080160	8.0	160	100	1
0121080210	8.0	210	150	1
0121080260	8.0	260	200	1
0121080310	8.0	310	250	1
0121080400	8.0	400	340	1
0121080460	8.0	460	400	1
0121080600	8.0	600	540	1
0121100160	10.0	160	100	1
0121100210	10.0	210	150	1
0121100260	10.0	260	200	1

Gereedschap & toebehoren

EUROFAST® Zentro & Konus

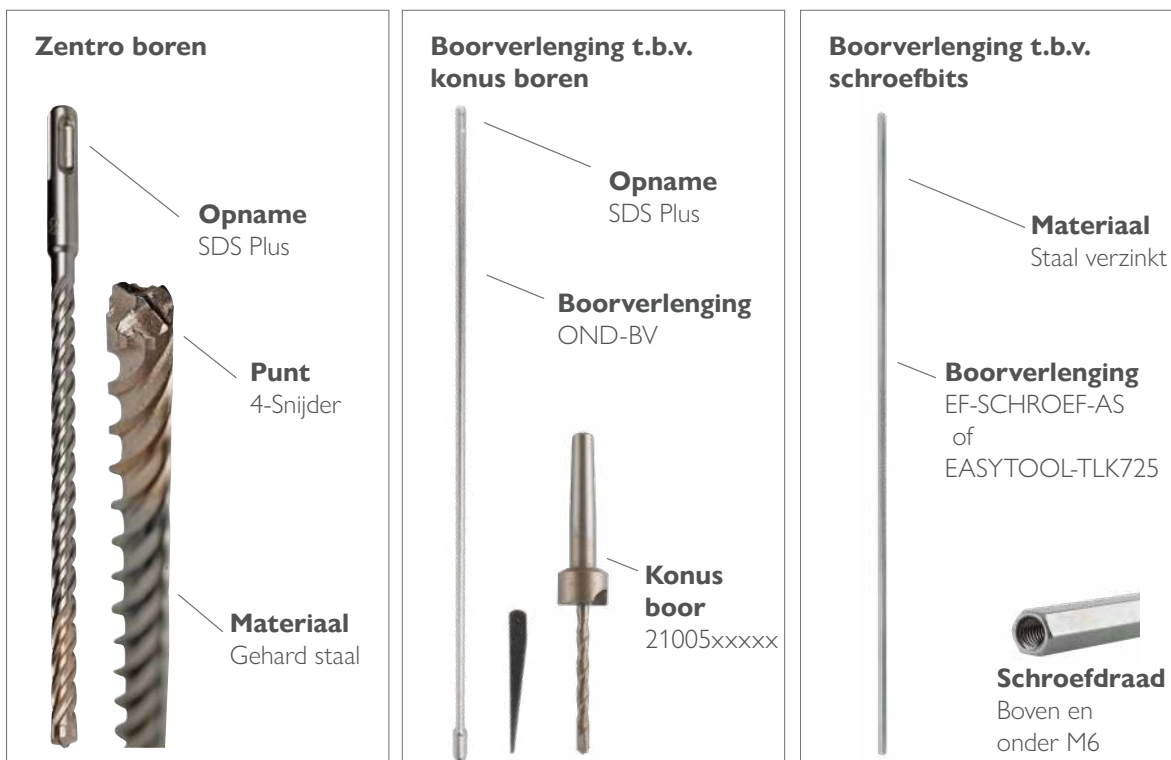

Product key	Afmetingen			
	Ø	Totaal	Nuttig	☒
0123060110	6.0	110	50	1
0123060160	6.0	160	100	1
0123080210	8.0	210	150	1
0123080260	8.0	260	200	1
0123080310	8.0	310	250	1
0123080460	8.0	460	400	1
0123080600	8.0	600	540	1

Product key	Afmetingen			
	Ø	Totaal	Nuttig	☒
2100520001	5.2	92	25	1
2100520002	5.2	102	35	1
2100520003	5.2	122	55	1
2100550001	5.5	92	25	1
2100550002	5.5	102	35	1
2100550003	5.5	122	55	1
2100550004	5.5	160	100	1
OND-BV-650		650		1
OND-BV-800		800		1
OND-BV-1100		1100		1
EF-SCHROEF-AS		745		1
EASYTOOL-TLK725	9.0	725		1

Schroefbit	Product key	Afmetingen			
		Ø	Type	Bit	☒
<p>Diameter Ø 8.0 mm</p>	240260502050	6.0	M5	PH2	1
	240260525045	8.0	M6	TX25	1
<p>Diameter Ø 9.35 mm</p>	240260525065	8.0	M6	PH2	1
	240260525050	9.35	M6	TX25	1
	240260525055	9.35	M6	PH2	1

Gereedschap & toebehoren

EUROFAST® Tool bits



Bithouder Product key	Type		☒
	Type		
240201414300	Felo High impact		1
240201414100	Magnetisch		1
240201414200	Magnetisch spring		1
240200000207	Universal SDS+		1
240201414302	Universal 1/4 quick lock		1



PHILIPS Product key	Afmetingen		
	Type	Lengte	☒
240211401025	PH1	25	1
240211402025	PH2	25	1
240211402050	PH2	50	1
240211402150	PH2	150	1
240211402250	PH2	250	1
240211402300	PH2	300	1
240211402350	PH2	350	1
240211403025	PH3	25	1
240211403050	PH3	50	1
240211403150	PH3	150	1
240211403250	PH3	250	1



POZIDRIVE Product key	Afmetingen		
	Type	Lengte	☒
240221401025	PZ1	25	1
240221402025	PZ2	25	1
240221403025	PZ3	25	1

Gereedschap & toebehoren



TORX Product key	Afmetingen		
	Type	Lengte	☒
240231420025	TX20	25	1
240231425025	TX25	25	1
240231425050	TX25	50	1
240231425150	TX25	150	1
240231425250	TX25	250	1
240231425300	TX25	300	1
240231425350	TX25	350	1
240231430025	TX30	25	1
240231430050	TX30	50	1
240231440025	TX40	25	1

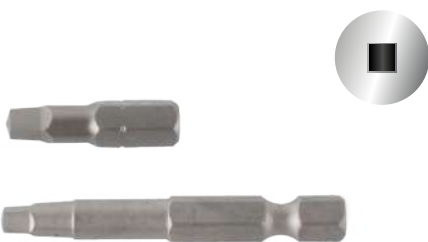

ROBERTSON Product key	Afmetingen		
	Type	Lengte	☒
240251402025	R2	25	1
240251402050	R2	50	1
240251403025	R3	25	1
240251403050	R3	50	1

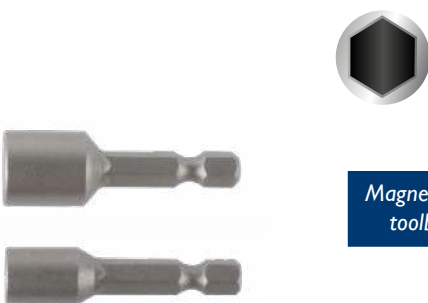

Magnetische
toolbits

HWH Product key	Afmetingen		
	Type	Lengte	☒
240271438000	HWH 3/8		1
240271408000	HWH 8 mm		1
240281408000	HWH 8 mm		1
240281410000	HWH 10 mm		1
240281401400	HWH 1/4 mm		1
240281403800	HWH 3/8 mm		1
240281405160	HWH 5/16 mm		1

Gereedschap & toebehoren

EUROFAST® HQ Tool bits



PHILIPS Product key	Afmetingen		
	Type	Lengte	☒
240111402025	PH2	25	1
240111402050	PH2	50	1
240111402150	PH2	150	1
240111402250	PH2	250	1
240111403025	PH3	25	1
240111403050	PH3	50	1
Toolbit-set			
EF-BITSETPH2HQ25	PH2	25	10
EF-BITSETPH2HQ50	PH2	50	10
EF-BITSETP2HQ150	PH2	150	5
EF-BITSETP2HQ250	PH2	250	5
EF-BITSETPH3HQ25	PH3	25	10
EF-BITSETPH3HQ50	PH3	50	10



POZIDRIVE Product key	Afmetingen		
	Type	Lengte	☒
240121402025	PZ2	25	1
240121402050	PZ2	50	1
240121403025	PZ3	25	1
240121403050	PZ3	50	1
Toolbit-set			
EF-BITSETPZ2HQ25	PZ2	25	10
EF-BITSETPZ2HQ50	PZ2	50	10
EF-BITSETPZ3HQ25	PZ3	25	10
EF-BITSETPZ3HQ50	PZ3	50	10

Gereedschap & toebehoren



TORX Product key	Afmetingen		
	Type	Lengte	☒
240131420025	TX20	25	1
240131420050	TX20	50	1
240131425025	TX25	25	1
240131425050	TX25	50	1
240131425150	TX25	150	1
240131425250	TX25	250	1
240131425300	TX25	300	1
240131430025	TX30	25	1
240131430050	TX30	50	1
240131440025	TX40	25	1
240131440050	TX40	50	1

Toolbit-set

EF-BITSETT20HQ25	TX20	25	10
EF-BITSETT25HQ25	TX25	25	10
EF-BITSETT25HQ50	TX25	50	10
EF-BITSET25HQ150	TX25	150	5
EF-BITSET25HQ250	TX25	250	5
EF-BITSET25HQ300	TX25	300	5
EF-BITSETT30HQ25	TX30	25	10
EF-BITSETT30HQ50	TX30	50	10
EF-BITSETT40HQ25	TX40	25	10
EF-BITSETT40HQ50	TX40	50	10



ROBERTSON Product key	Afmetingen		
	Type	Lengte	☒
240151402050	R2	50	1

Ergonomische verwerkingsmachines

EUROFAST® DEK-FIX

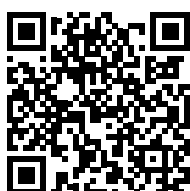

Instructie video

Materiaal

Lichtmetalen bouw

Diepteanslag

Max. schroeflengte
240 mm



Schroefbit

HWH 8 mm
OND-DFX-6.1.6



Toepassing

Machinale verwerking voor schroeven op band: EDS-BGT, EDS-BGTHD en EDS-BGTR.

Transportkist

De Eurofast® DEK-FIX wordt geleverd in een transportkist inclusief toolkit en handleiding. Voor de gebruikersinstructie kun je terecht op www.eurofastgroup.com

Ergonomische verwerkingsmachines

EUROFAST® EURO-FIX



Instructie video

Diepteanslag
Max. opbouw
260 mm



Materiaal
Lichtmetalen bouw

Schroefbit
TX25 M6
240260525050



PH2 M6
240260525055



Toepassing

Machinale verwerking voor tule combinaties op band: TRPSG-45, TWPSG-45, TRPBG-45, TWPSB-45, TRPSRBG-45, TRPHG-45 en TWPHG-45.

Transportkist

De Eurofast® EURO-FIX wordt geleverd in een transportkist inclusief toolkit en handleiding. Voor de gebruikersinstructie kun je terecht op www.eurofastgroup.com

Ergonomische verwerkingsmachines

EUROFAST® SINGLE-FIX



Instructie video

**Diepteanslag**Max. boordiepte
400 mm**Materiaal**Lichtmetalen
bouw**Boorhamers**

1x Hitachi DH28P

Zuigslang

Incl. 10 meter

**Speciaal ontworpen
afzuig systeem****Gewicht**

14.84 Kg

Inhoud

15L

Motor

620 W vermogen

**Transportkist**

De Eurofast® SINGLE-FIX wordt met bijbehorende stofzuiger geleverd in een transportkist inclusief handleiding. Voor de gebruikersinstructie kun je terecht op

www.eurofastgroup.com

Ergonomische verwerkingsmachines

EUROFAST® TRIPLE-FIX



Instructie video



Diepteanslag
Max. boordiepte
400 mm

Materiaal
Lichtmetalen
bouw

Boorhamers
3x Hitachi DH28P

Zuigslang
Incl. 10 meter



**Speciaal ontworpen
afzuig systeem**

Motor
620 W vermogen



Gewicht
14.84 Kg

Inhoud
15L

TNO gecertificeerd
De Eurofast® TRIPLE-FIX heeft het TNO certificaat mogen ontvangen.

Transportkist
De Eurofast® TRIPLE-FIX wordt met bijbehorende stofzuiger geleverd in een transportkist inclusief handleiding. Voor de gebruikersinstructie kun je terecht op www.eurofastgroup.com

Ergonomische verwerkingsmachines

EUROFAST® EASYTOOL-TRP-TWP



Adapter
ET-ADAPT-MAKITA



ET-ADAPT-HITACHI



ET-ADAPT-HILTI



ET-ADAPT-WURTH

**Extra optie**

Eurofast® Gordeltas
TPP-GORDEL



Eurofast® TRP-45 & TWP-8040



Ergonomische verwerkingsmachines

EUROFAST® EASYTOOL-TLK



Adapter
ET-ADAPT-MAKITA



ET-ADAPT-HITACHI



ET-ADAPT-HILTI



ET-ADAPT-WURTH



Extra optie
Eurofast® Gordeltas
TPP-GORDEL



Ergonomische verwerkingsmachines

EUROFAST® EASYTOOL-PRO



Instructie video

Schroefbit

TX25 M6
240260525050

PH2 M6

240260525055

Adapter

ET-ADAPT-MAKITA

ET-ADAPT-HITACHI

ET-ADAPT-HILTI

ET-ADAPT-WURTH

Extra optie

Eurofast® Gordeltas
TPP-GORDEL

Niet voor verwerking in beton.

Eurofast® TRP-45



Eurofast® TLK-45



Eurofast® TLK-75



Ergonomische verwerkingsmachines

EUROFAST® SHORT TOOL

Short tool



Extra optie

Eurofast® Gordeltas
TPP-GORDEL



OND-DF-SHORT (PH3)
5.5 / 6.0 / 6.7 mm



Toolbit
240211403050



OND-EF-SHORT (PH2)
4.8 mm



Toolbit
240211402050



OND-BZ-SHORT (HWH8)
4, 8 mm



Toolbit
240281408000



EF-EXTENS
Universeel verlengstuk



Ergonomische verwerkingsmachines

EUROFAST® Rivet tools



Extra optie

Modellen op aanvraag

EUROFAST® Voorprikker

Toepassing

Voor het voorprikken van bitumen dakbanen. Te gebruiken bij renovatie projecten waarbij tule combinaties worden toegepast.

VOORPRIKKER

